

## Resource consumption of the passenger vehicle sector in Germany until 2035 – the impact of different drive systems

Study on behalf of the German Federal Ministry for  
the Environment, Nature Conservation and Nuclear  
Safety

Darmstadt,  
28.05.2021

### Authors

Johannes Betz (Oeko-Institut),  
Matthias Buchert (Oeko-Institut),  
Peter Dolega (Oeko-Institut),  
Winfried Bulach (Oeko-Institut)

### Scientific Review

Lucien Mathieu (T&E),  
Hinrich Helms (Ifeu institute)

### Head Office Freiburg

P.O. Box 17 71  
79017 Freiburg  
**Street address**  
Merzhauser Strasse 173  
79100 Freiburg  
Tel. +49 761 45295-0

### Office Berlin

Borkumstraße 2  
13189 Berlin  
Tel. +49 30 405085-0

### Office Darmstadt

Rheinstrasse 95  
64295 Darmstadt  
Tel. +49 6151 8191-0

[info@oeko.de](mailto:info@oeko.de)  
[www.oeko.de](http://www.oeko.de)



# Table of Contents

<b>List of Figures</b>	<b>5</b>
<b>List of Tables</b>	<b>8</b>
<b>List of Abbreviations</b>	<b>9</b>
<b>Executive Summary</b>	<b>11</b>
<b>1 Objectives of the study</b>	<b>14</b>
<b>2 Methodical procedure</b>	<b>15</b>
2.1 Definition of the drive systems	15
2.2 Modelling of demand scenarios for Germany	17
<b>3 Scenario results on resource consumption</b>	<b>18</b>
3.1 Raw material demand of petrol and diesel for passenger cars	21
3.2 Raw material demand for automotive catalysts	27
3.3 Raw material demand for traction batteries and electric motors	28
3.4 Raw material demand for additional wind power and PV infrastructure (national electricity mix)	33
3.5 Fossil energy carrier demand for charging EVs	36
3.6 Excursus: Raw material demand for additional wind power and PV infrastructure with 100 % renewable energy used for EVs	38
3.7 Excursus: Cumulative Raw Material Demand (CRD)	40
<b>4 Identification of ecological and social “hot spots” of raw material extraction</b>	<b>43</b>
<b>4.1 Key raw materials for ICEs</b>	<b>45</b>
4.1.1 Crude oil	45
4.1.1.1 Crude oil from Russia	50
4.1.1.2 Crude oil from Norway	52
4.1.1.3 Crude oil from Libya	53
4.1.1.4 Crude oil from Nigeria	55
4.1.1.5 Crude oil from the USA	58
4.1.2 Platinum group metals	62
4.1.2.1 PGM mining in South Africa	63
4.1.2.2 PGM mining in Russia	64
<b>4.2 Key raw materials for EV</b>	<b>66</b>
4.2.1 Lithium	66

---

4.2.1.1	Lithium brine-mining in South America	67
4.2.1.2	Australian hard-rock mining of lithium	69
4.2.2	Cobalt	71
4.2.3	Nickel	76
4.2.4	Graphite	78
4.2.5	Rare earths elements (REE)	82
<b>5</b>	<b>Summary and conclusions</b>	<b>86</b>
<b>6</b>	<b>Recommendations</b>	<b>88</b>
<b>7</b>	<b>References</b>	<b>90</b>

## List of Figures

Figure 1 National electricity mix and development 2020 - 2035, data from Harthan et al., 2020	18
Figure 2 Passenger vehicle sales in Germany, 2020-2035, under the Combustion Scenario, by drive system	19
Figure 3 Passenger vehicle sales in Germany, 2020-2035, under the EV Scenario, by powertrain	19
Figure 4 Development of the passenger vehicle stock (Combustion Scenario)	21
Figure 5 Development of the passenger vehicle stock (EV Scenario)	21
Figure 6 Scheme of an exemplary oil refinement process (omitting liquefied petroleum gas (LPG) for more clarity)	22
Figure 7 Crude oil demand in the Combustion Scenario, 2020-2035, in million litres of oil	23
Figure 8 Crude oil demand for fuel for passenger vehicles in the EV Scenario	23
Figure 9 Platinum net demand for oil refining catalysts, in tonnes per year	25
Figure 10 Rhenium net demand for oil refining catalysts, in tonnes per year	25
Figure 11 Molybdenum net demand for oil refining catalysts, in tonnes per year,	26
Figure 12 Cobalt net demand for oil refining catalysts in tonnes per year	26
Figure 13 PGM demand for catalysts, in tonnes per year	27
Figure 14 Cerium demand for catalysts, in tonnes per year	28
Figure 15 Demand for LIB per scenario, in tonnes	28
Figure 16 Current development trend for cell chemistries in traction batteries placed on the market between 2020 and 2035 [based on own estimations]	29
Figure 17 Cobalt and lithium demand for traction batteries, per model scenario, in tonnes	30
Figure 18 Copper and nickel demand for traction batteries, per model scenario, in tonnes	30
Figure 19 Graphite demand for traction batteries per scenario, in tonnes	31
Figure 20 REE demand for NdFeB magnets demand for electric motors, in tonnes of metals	32
Figure 21 Copper demand for electric motors per scenario, in tonnes of metal	32
Figure 22 Cumulative REE demand for additional wind turbines for EVs between 2020 and 2035, in tonnes (national electricity mix)	34
Figure 23 Market share of different PV types between 2020 and 2035	34
Figure 24 Cumulative indium demand for additional PV systems for EVs between 2020 and 2035, in tonnes (national electricity mix)	35
Figure 25 Cumulative silicon (crystalline) demand for additional PV systems for EVs between 2020 and 2035 (national electricity mix)	36
Figure 26 Combustion Scenario: demand for fossil energy carriers for charging EVs, in tonnes	37
Figure 27 EV Scenario: demand for fossil energy carriers for charging EVs, in tonnes	37

Figure 28 Cumulative REE demand for additional wind turbines for EVs between 2020 and 2035 (100 % renewables), in tonnes	38
Figure 29 Cumulative indium demand for additional PV systems for EVs between 2020 and 2035 (100 % renewables), in tonnes	39
Figure 30 Cumulative silicon (crystalline) demand for additional PV systems for EVs between 2020 and 2035 (100 % renewables), in tonnes	39
Figure 31 Cumulative Raw Material Demand (CRD) 2020-2035 (cumulated), in tonnes	40
Figure 32 Cumulative Raw Material Demand (CRD) by recyclability, 2020-2035 (cumulated), in tonnes	42
Figure 33 Demand for fossil fuels and selected metals in 2035 under the two scenarios, in tonnes	43
Figure 34 Worldwide proven oil reserves in 2017, in millions of barrels	46
Figure 35 Import of crude oil to Germany, 1990-2018, in thousand tonnes (data from [BMWl 2019] and [BAFA 2020])	47
Figure 36 Average daily crude oil production of the main crude oil suppliers for Germany, in thousand barrels, 2008-2018	48
Figure 37 Workers cleaning a beach after an oil spill	48
Figure 38 Oil platform while flaring APG	49
Figure 39 Permafrost extent in Russia, taken from [Streletskiy et al. 2019]	51
Figure 40 Oil Rigs outside Bergen, Norway	52
Figure 41 Oil and gas industry in Libya	54
Figure 42 Oil contamination in Ogoni land, Nigeria	56
Figure 43 Crude oil production in the USA from 1900 until 2020	58
Figure 44 Schematic depiction of hydraulic fracturing for shale gas, showing main possible environmental effects	59
Figure 45 Burning oil platform Deepwater Horizon	60
Figure 46 Oiled bird after an oil spill	61
Figure 47 Platinum – Share of world mine production 2019 [USGS 2021 A]	62
Figure 48 Palladium – Share of world mine production 2019 [USGS 2021 A]	63
Figure 49 Quarry in Norilsk	65
Figure 50 Global lithium production (metric tonnes of lithium content) by country, 2016-2018	67
Figure 51 Lithium salt extraction from salt lakes	68
Figure 52 Cobalt mine production by country in 2018, in tonnes [USGS 2020 A]	72
Figure 53 Example of an artisanal mine	73
Figure 54 Example of acid mine drainage	74
Figure 55 Nickel mine production by country in 2018 in tonnes [USGS 2020 A]	76
Figure 56 Nickel reserves by country in tonnes in 2018 [USGS 2020 A]	77
Figure 57 Open-pit mining corridor fragmenting the landscape	80
Figure 58 Rare earths world mine production in 2019 [USGS 2021 B]	83
Figure 59 Risks of rare earth mining with or without insufficient environmental protection systems [Schueler et al. 2011]	84

Figure 60 Rare earth extraction in Bayan-Obo (China): Sites with elevated levels of  
radioactivity [Qifan 2010]

85

## List of Tables

Table 1 Overview of relevant vehicle components, infrastructure and associated essential raw materials for passenger vehicles with different powertrains	16
Table 2 Overview of assumed average fuel economy and efficiency gains	17
Table 3 Prioritisation of the quantified raw materials for further investigation	43
Table 4 Ranking scheme for overall assessment of raw materials	44
Table 5 Ranking scheme (stoplight colour code) for overall assessment of raw materials	86
Table 6 Overview assessment of social and environmental impacts of resource demand	86



## List of Abbreviations

a-Si	Amorphous silicon
AMD	Acid mine drainage
APG	Associated petroleum gas
ASM	Artisanal and small-scale mining
BEV	Battery electric vehicle
c-Si	Crystalline silicon
CdTe	Cadmium telluride
CIGS	Copper indium gallium di-selenide
Co	Cobalt
Cu	Copper
DD-EESG	Direct drive–electrically excited synchronous generator
DD-PMSG	Direct drive–permanent magnet synchronous generator
DRC	Democratic Republic of the Congo
EESM	Electrically excited synchronous motors
EHS	Environmental, health and safety
EU	European Union
EV	Electric vehicles
FCEV	Fuel cell electric vehicles
GB-DFIG	Gear box–double-fed induction generator
GB-PMSG	Gear box–permanent magnet synchronous generator
GHG	Greenhouse gasses
HDS	High Demand Scenario
HEV	Hybrid electric vehicle
HoR	House of Representatives
ICE	Vehicle with an internal combustion engine (diesel or petrol)
JRC	Joint Research Centre
KBA	Kraftfahrtbundesamt (German Federal Motor Transport Authority)
Kg	Kilogramme

LCA	Life cycle assessment
LCO	Lithium cobalt oxide
Li	Lithium
LIB	Lithium ion battery
LPG	Liquefied petroleum gas
Mo	Molybdenum
Mt	Megatonne or million tonnes
MW	Megawatt
NCA	Lithium nickel cobalt aluminium oxide
NdFeB	Neodymium iron boron magnets
NG	Natural graphite
Ni	Nickel
NMC	Lithium nickel manganese cobalt oxide
NOC	National Oil Corporation
Pd	Palladium
PGM	Platinum group metals
PHEV	Plug-in hybrid electric vehicle
PSM	Permanent magnet synchronous motors
Pt	Platinum
PtL	Power-to-liquid
PV	Photovoltaic
Re	Rhenium
REE	Rare earth elements
SG	Synthetic graphite
SLO	Social license to operate
t	(Metric) tonne
TSF	Tailings storage facilities
UNEP	United Nations Environment Programme
WTT	Well-to-tank

## Executive Summary

The automotive sector is undergoing a wide-ranging transformation, with the rapid development of vehicle electrification a particular focus. The consumption of resources for core components of electric vehicles – first and foremost lithium-ion batteries – is being critically questioned against the background of environmental pollution and negative social impacts from the extraction of raw materials. What is missing is a comprehensive analysis of the impacts and, above all, a fair comparison of the impacts of different powertrains that includes the resource implications of the fossil-fuel supply chain. This study contributes to closing this gap by comparing and evaluating possible developments of Germany's passenger vehicle sector from a resource perspective until 2035.

For this purpose, two very different scenarios for the possible development of the passenger vehicle sector up to 2035 in Germany were defined to clearly highlight the main differences in the resource implications. A combustion vehicle and an electric vehicle (EV) scenario were compared. The various drive systems - internal combustion engine (ICE), hybrid (HEV), plug-in hybrid (PHEV) and battery electric vehicle (BEV) - provide the parameters for simulating different developments.

The **Combustion Scenario** assumes a highly conservative development of the passenger vehicle sector, where electric vehicles gain ground only very slowly until 2035. In this scenario, the share of ICEs of all new vehicle registrations would still be almost 60 %, even in 2035.

In the **EV Scenario**, on the other hand, electric vehicles develop very dynamically in Germany. In 2030, BEVs would already account for 52.5 % of new passenger vehicle registrations. And from 2035, according to the EV Scenario, only BEVs would be registered in the passenger vehicle market in Germany. To clearly work out the effect of different shares of powertrain types on the resource requirements between the two scenarios, the same amount of annual registrations, approximately 3.2-3.3 million passenger vehicles, were assumed for each of the two scenarios. Vehicular components and their requisite raw materials that are contained in both EVs and ICEs (e.g. tyres, bodywork, windscreens, suspension, etc.) were not considered in the study. These components and materials were excluded since the raw material requirements for them hardly differ between vehicles with different drive systems. Consequently, the study focuses strictly on the components and the key materials that differ between each drive system. These include, for example, car exhaust catalytic converters, which are necessary for cars with combustion engines, or lithium-ion batteries for EVs. In addition, the energy sources needed to power the cars – i.e. diesel and petrol as well as electrical energy (a growing share of renewable energy sources has been calculated for the electricity mix in Germany; in 2035 this share is expected to be around 69 %) – and the building of required infrastructure are included in the consideration of the resource demand.

In summary, the following main conclusions can be drawn from the results of this study:

- **In 2035, annual crude oil demand can be cut by 56 % of the demand in 2020:** The results of the EV Scenario – where 100 % of new cars are BEVs in 2035 – show that an ambitious market ramp-up of electric vehicles in the German passenger car sector by 2035 can cut the annual crude oil demand by 56 % in the German passenger car sector by 2035 compared to 2020. This will result in a significant reduction of the necessary oil processing infrastructure in the medium term. These crude oil savings are much higher than the fossil energy sources needed to cover the additional electricity demand for electric vehicles. Thus, an ambitious market ramp-up of electromobility is associated with very high net savings of fossil energy sources (in tonnes).
- **Reduced oil demand implies reduced impacts from oil sourcing, as Germany imports most of its crude oil from countries with weak environmental and social standards:** The majority of crude oil imported to Germany (and to the EU) currently comes from producing countries with

mediocre to poor or very poor standards for reducing environmental impacts or negative social effects from crude oil production. Moreover, criteria for crude oil procurement for Germany according to social and environmental aspects are still missing, despite the high relevance of crude oil in road transport over the last decades. In contrast to metals, there is still a lack of critical and systematic debate on crude oil.

- **Raw materials for batteries and electric motors are dominant in the EV Scenario:** The EV Scenario, on the other hand, results in a growing demand for materials such as copper, nickel, cobalt, lithium, and rare earth elements. These materials are mainly needed for batteries and electric motors, while raw material requirements for the expansion of wind power and photovoltaic (PV) to provide electricity for the expanded EV fleet are significantly lower.
- **Higher secondary metal content and stricter environmental and social standards in primary raw material extraction are key to reducing environmental impacts:** Several metals for core components of electro-mobility are currently extracted in countries with very poor environmental and social standards. However, there is potential for reducing the negative environmental and social impacts of raw material extraction to meet the future metal demand. Ambitious recycling and higher secondary metal shares as well as strict governmental regulations and company policies for the supply chain of key metals from primary supply are important building blocks for ensuring reduced environmental impacts.
- **Peak in primary metal demand by 2035 at the latest, under the EV Scenario:** Since in the EV Scenario 100 % of new passenger vehicles in Germany would be BEVs in 2035 and secondary metal quotas should rise continuously over the next years, the peak primary metal consumption for the passenger car sector should already be reached around 2035. The resource demand for fossil fuels will already have declined sharply by 2035 and will tend towards zero in the years thereafter until 2050 at the latest.
- **Zero PGM demand for automotive catalysts in 2035:** Consumption of platinum group metals (PGMs) for automotive catalytic converters under the EV Scenario will also fall sharply – to zero in 2035. As PGMs from automotive catalysts represent an important secondary metal source through recycling, the recovered PGMs can be used to supply material for future applications such as fuel cells and the hydrogen infrastructure in the medium term.
- **Fossil fuels are wasted after use, but metals can be recycled:** In 2035, when comparing the EV Scenario with the Combustion Scenario, around 6.7 million tonnes of fossil fuels (petrol, diesel, lignite, etc.) are saved, while an additional amount of roughly 185 000 tonnes of metals are needed in 2035. The additional metals needed in the EV Scenario can be kept in a circular economy through recycling. Fossil fuels, on the other hand, are lost after combustion and pose an economic burden (e.g. through CO<sub>2</sub> pricing), while metals recycling can stimulate economic growth.

Against this background, the following recommendations can be derived from the results of the study:

### **Mandatory supply-chain due diligence for key battery materials**

The debate regarding mandatory supply-chain due diligence for all materials is gaining pace on the EU level through manifold regulations. Among others, the recently published proposal for an update of the Battery Regulation addresses mandatory supply-chain due diligence, referring to the OECD Due Diligence Guidance<sup>1</sup>. These developments are of crucial importance to establishing a level playing field.

<sup>1</sup> OECD Due Diligence Guidance for Responsible Supply Chains of Minerals from Conflict-Affected and High-Risk Areas

Currently responsible companies are facing economic disadvantages by applying high standards, while companies performing badly are at a competitive advantage due to lower operation costs. In the context of the rapid uptake of EVs in the mid-term, the largest share of supply will have to be covered by primary sources. Recycling clearly is of central importance but will not be able to fulfil significant portions of demand in the short-term (also see other recommendations). EVs are also promoted as the environmentally 'cleaner' option for individual mobility. Considering this argument, it is even more important to make sure that the raw materials required to make these vehicles are produced in a responsible and sustainable manner.

Mandatory supply-chain due diligence could ensure a level playing field and the possibility for security of investment by promoting cleaner and better extraction. Accordingly, it is recommended that the German Federal Government support the EU Commission's endeavours regarding supply-chain due diligence. This also applies to other key raw materials such as rare earth elements for electric motors and wind turbines.

### **Demand ambitious recycling targets for key materials for batteries**

Recycling of strategic metals, such as cobalt, lithium, copper and nickel from lithium-ion batteries, is critical to the sustainable expansion of electro-mobility in the EU and a step towards building a significant domestic source of raw materials ('mine above ground'). The German Federal Government should therefore support the EU Commission's proposal on the EU Batteries Regulation – i.e. the introduction of ambitious material-specific recovery quotas for copper, cobalt, nickel and lithium; the proposals on future recycled content; as well as the other proposed measures – which together represent a milestone for the Circular Economy in Europe.

### **Entering a recycling economy also for rare earth elements in Europe**

Furthermore, it is recommended that the German Federal Government strongly support and continue the existing German and European research and development activities to establish a European cycle for rare earth elements from spent neodymium-iron-boron magnets (from EV motors and wind power generators). This would support the goal of reducing Germany's and the EU's dependence on non-European supplier countries with great market dominance.

### **Accelerating the expansion of renewable energies for the power sector**

The scenario results from this study indicate that the additional demand for key materials to electrify the passenger vehicle fleet is primarily due to the production of the vehicle itself and not primarily due to the upstream electricity needs (i.e. the expansion of wind power and PV infrastructure). Electric vehicles are highly energy efficient and the additional electricity needs are limited, when compared to power-to-liquid options. The further expansion of wind power and photovoltaic (PV) clearly brings resource advantages (and of course reduces greenhouse gas emissions) by further minimising the share of fossil fuels used in Germany's electricity mix. The German Federal Government is therefore recommended to accelerate expanding wind power (onshore and offshore) and PV infrastructure.

### **Responsible sourcing criteria for remaining crude oil production**

The argument for electrifying the German passenger vehicle fleet can easily be based on a resource perspective, when considering the negative impacts of oil sourcing. Even if fossil fuel use may be on its way out in Germany, the question remains why the issues and impacts of oil sourcing have gained little attention for decades. It is recommended that the German Federal Government develop and adopt criteria for crude oil extraction that include strict requirements to minimise the negative environmental and social impacts as much as possible.

## 1 Objectives of the study

When comparing the environmental effects of different drive systems for passenger cars, studies usually focus on the impacts on climate change. In more comprehensive life cycle assessments (LCAs), further environmental impact categories, such as ‘acidification potential’ and ‘ground-level ozone formation potential’, are also considered. The debate has often largely focused on the environmental impact of emissions from these vehicles into the air, addressing carbon dioxide emissions (greenhouse gas effect), nitrogen oxides (acidification potential, etc.) and other ‘classic emissions’ such as particulate matter [Schallaböck et al. 2006, Heinze et al. 2016].

With the advance of alternative powertrains for passenger cars – mainly battery electric vehicles or hybrids – the focus of environmental assessments has become broader. With the increasing importance of electric mobility, resource issues have come strongly to the fore in recent years. The often highly critical discussions focus on key materials in lithium-ion batteries (LIBs) such as lithium and cobalt, which are at the heart of this alternative technology. Resource discussions span issues of availability or scarcity of raw materials, questions of economic viability, and, not least, the social and environmental impacts of raw material extraction and processing. This explains why in recent years many scientific reports, as well as magazine articles and television documentaries, report on the effects of the increasing demand for battery materials [Buchert et al. 2017, IV 2019, Staude 2019].

The intensive discussions on the extraction of important raw materials for LIBs and for other critical components of electric vehicles are important and correct – especially in this early phase of the global market ramp-up towards electric mobility. It is striking, however, that no equal attention is paid to the impact of raw material extraction for key materials used in combustion engine vehicles. This applies primarily to the extraction of the basic resource crude oil as well as to the extraction of specific materials such as platinum group metals, which are essential for the function of automotive catalytic converters. The primary goal of this study is therefore to fill this serious research gap by comparing the social and environmental impacts of extracting all key raw materials for internal combustion engine (ICE) vehicles as well as for battery electric (BEV) and various types of hybrid electric vehicles (PHEV and HEV) on an equally weighted basis.

At this point, it should be emphasised that this study does not include a climate or life cycle assessment to compare the different drive systems for passenger vehicles. Rather, the focus is exclusively on the investigation and evaluation of the social and ecological impacts of raw material extraction that is necessary both for manufacturing the vehicle components and for operating the vehicles (fuels, electricity). To calculate the raw material demand of the different drive systems and to demonstrate the associated social and environmental impacts in their extraction, two different scenarios for the development of the passenger vehicle market in Germany up to 2035 are compared.

Section 2 of this study describes the methodological approach in detail, laying out the definitions for the examined. The system boundaries, the temporal coverage and other important data and parameters for the scenarios for the German passenger vehicle sector are described. Section 3 provides the comprehensive scenario results on resource consumption for the different scenarios. Section 4 addresses the main issues and challenges in terms of social and environmental impacts for the extraction of raw materials that are characteristic and relevant for the different drive systems. Section 5 provides a summary and conclusions, and Section 6 offers recommendations that can be derived from the work.



## 2 Methodical procedure

This section presents the essential elements of the methodological approach. First, subsection 2.1 introduces the drive systems that are the focus of the work. Furthermore, the relevant vehicle components, infrastructures and associated key raw materials are addressed. Subsection 2.2 presents the main assumptions and input data for the two scenarios that depict the possible development of the passenger vehicle sector in Germany.

### 2.1 Definition of the drive systems

There are a wide variety of terms to describe the type of technology that moves a vehicle. This includes terms such as ‘powertrain’, ‘drive system’, ‘drive type’, ‘propulsion system’, etc. The terms all differ slightly in their definitions and the components of a vehicle that are included. In this study, the terms are all used synonymously to differentiate between vehicles powered by a battery (BEV), by an internal combustion engine (ICE) or by both (PHEV, HEV) [compare e.g. VDA 2009].

For the in-depth investigation of the resource demand of the passenger vehicle sector in Germany and the associated social and environmental impacts of raw material extraction, the following propulsion systems are considered in the scenarios:

- ICE: vehicle with an internal combustion engine (diesel or petrol)
- BEV: battery electric vehicle,
- HEV: hybrid electric vehicle
- PHEV: plug-in hybrid electric vehicle

Passenger cars with other propulsion systems, such as fuel cell vehicles (FCEV), were excluded from this study, as only very few of these vehicles are expected to be in use during the timeframe studied in the scenarios (see below). In the context of this study natural gas vehicles are treated as ICEs as they are based on the same principles using a different fossil fuel. FCEV are comparable to BEVs since they also contain a battery and an electric motor, resulting in a very roughly comparable resource demand (when excluding the fuel cell itself).

For this study, we ignore vehicular components and the requisite raw materials that are contained in both electric vehicles and internal combustion vehicles; for example tyres, bodywork, windscreens, suspension etc. This exclusion is based on the idea that the raw material requirements for these components hardly differ between vehicles with different powertrains. Consequently, the study focuses on the components and the essential materials they contain that are characteristic to the specified powertrain. Furthermore, the energy sources required to power the vehicles – i.e. diesel and petrol as well as electrical energy – are included in the analysis of the resource issues.

The overarching methodological guideline for the scenarios and the study as a whole is to obtain a fair comparison of resources effects used for the different powertrains. Table 1 summarises the vehicle components that are characteristic for ICE, BEV, HEV and PHEV. Furthermore, the table gives an overview of the most important elements in each of these vehicle components. Finally, it also provides information on the relevant energy sources for the drive system of the different types of passenger vehicles, i.e. diesel, petrol, and electricity. The research also includes important raw materials and key elements for the provision of the infrastructure to supply diesel, petrol, and electricity. These include selected metals needed for industrial catalysts in petroleum refineries, essential materials for additionally required capacities at wind power and photovoltaic (PV) plants, as well as fossil fuels for power generation, such as hard coal, lignite, and natural gas.

**Table 1 Overview of relevant vehicle components, infrastructure and associated essential raw materials for passenger vehicles with different powertrains**

Relevant vehicle components, infrastructures and associated essential raw materials	ICE	BEV	HEV	PHEV
Raw material demand for traction batteries, electric motors		x	x	x
Materials in focus for batteries: lithium, cobalt, nickel, copper, graphite		x	x	x
Materials in focus for electric motors: copper and rare earth elements		x	x	x
National electricity mix (only use-phase) and main electricity infrastructure		x		x
Essential raw materials for production of electricity: hard coal, lignite, natural gas,		x		x
Raw materials for additional renewable electricity infrastructure: copper (wind power), rare earth elements (wind power), silicon (PV), indium (PV)		x		x
Diesel and petrol demand	x		x	x
Supply chain for diesel and petrol: oil refineries	x		x	x
Materials in focus for oil refineries: molybdenum, cobalt, rhodium, platinum	x		x	x
Raw material demand for engine, transmission, catalytic converter	x		x	x
Materials in focus for engine, transmission: steel, aluminium	x		x	x
Materials in focus for catalytic converters: rare earths element cerium, platinum group metals (platinum, palladium, rhodium)	x		x	x

Further detailed information can be found in section 3.

The study focuses on the most important components (lithium-ion batteries etc.) and processes (e.g. infrastructure for PV and wind turbines) over the next few years; therefore, components and processes for which only minor demand and impacts are expected as well as infrastructure that will be phased out over the next few years were excluded. As a result, the resource demand to produce electricity from nuclear energy (i.e. uranium ore) was not included, as the last nuclear reactors in Germany are scheduled to be phased out by the end of 2022. Likewise, no infrastructure expenditures were considered for hard coal or lignite-fired power plants, since decommissioning of the last existing power plants is scheduled by 2038. The same exclusion applies to gas-fired power plants for electricity generation because the long term (2050) goals of the German government aim to decarbonise electricity generation by switching to renewable energy sources.

The study also does not consider the share of biofuels in diesel and petrol, as this share is only minimal<sup>2</sup>. New technologies currently under development, such as power-to-liquid (PtL), are not yet marketable in the foreseeable future and are therefore also not considered in this study. In this context, however, it is relevant to point out that a vehicle driving with PtL has only about 13 % efficiency in relation to the electricity generated due to the conversion losses. A BEV, on the other hand, has

<sup>2</sup> Although biofuels do have various advantages with regards to e.g. greenhouse gas emissions or pollution when compared to fossil fuels, disadvantages are also present e.g. related to land use. However, the issue of land use is not addressed in this study.



an efficiency of 69 % in relation to the electricity generated [Perner et al. 2018]. It may be noted that synthetic fuels based on PtL are being discussed primarily for use in other sectors, in particular for aviation fuel. Hence, vehicles powered by natural gas or liquefied gas engines are excluded from the study, as their market relevance is only marginal.

## 2.2 Modelling of demand scenarios for Germany

Within the framework of this study, two different scenarios were defined for the passenger vehicle sector in Germany to clearly highlight the possible differences in the demand for raw materials and their effects. The timeframe 2020 to 2035 was chosen as the scenario period. The ‘Combustion Scenario’ is based on the assumptions of the German government’s 2030 climate protection programme for the passenger vehicle sector [Bundesregierung 2019, Harthan et al. 2020]. In the second scenario, referred to as the ‘EV Scenario’, a significantly faster market penetration of passenger vehicles with electric drives is assumed to more quickly reduce carbon dioxide emissions from the transport sector. Thus, in this second scenario, only purely battery-electric passenger vehicles will enter the market in Germany from 2035 onward. To clearly allocate the effects of the different drive systems on resource demand over the scenario period, identical absolute annual new registrations for all passenger vehicles were assumed for each scenario. These absolute passenger vehicle new registrations correspond to the amounts from the Federal Government’s Climate Protection Programme 2030 and are then differentiated by ICE, BEV, HEV and PHEV in section 3 of this paper.

According to statistics from the German Federal Motor Transport Authority [KBA 2020], the following average annual kilometres per year for diesel cars (including HEV) and petrol cars (including HEV and PHEV) is assumed for both scenarios. Since no statistical data on average kilometres per year for BEVs is available, an intermediate value located between diesel and petrol vehicles is estimated:

- Diesel (HEV)                    20 000 km/ yr
- Petrol (HEV, PHEV)        10 000 km/ yr
- BEV                                15 000 km/ yr

Table 2 shows the assumptions for the average fuel and energy consumption (over the scenario period 2020-2035) differentiated by the corresponding vehicle types<sup>3</sup>.

**Table 2 Overview of assumed average fuel economy and efficiency gains**

	Fuel economy (avg. l/100 km)	% change between 2020 and 2035
Diesel	6.5	-10 %
Diesel HEV	5.1	-10 %
Petrol	5.2	-10 %
Petrol HEV	4.1	-10 %
Petrol PHEV	3.8	-10 %
	<b>Electric energy consumption (avg. kWh/ 100 km)</b>	
PHEV	6.7	+2 %
BEV	14.7	+2 %

<sup>3</sup> Fuel consumption based on own estimation (Oeko-Institut); for PHEV, own calculations based on [Plötz et al. 2020].

It must be noted that the values given in Table 2 are average values for the considered time frame between 2020 and 2035. The consumption values for fuel in the starting year 2020 are higher for vehicles with combustion engines and lower in 2035 than the displayed average values. The values for BEVs and PHEV for electric energy consumption are assumed to be lower in 2020 and higher in 2035, since a trend towards slightly bigger batteries can be assumed combined with more powerful electric engines and further electrification of larger vehicle classes. In the case of PHEV, a higher share of purely electric use is assumed for the future; therefore, energy demand increases with time while fuel consumption decreases. These assumptions consider foreseeable technological developments in passenger vehicles with internal combustion engines.

The next Figure 1 documents the development of the electricity mix in Germany between 2020 and 2035, which is used for both scenarios. The assumed development of the electricity mix considers decisions made by the German government, such as phasing out of nuclear energy by the end of 2022 and of coal-fired power generation by latest 2038. The planned expansion of the share of renewable energy sources in electricity generation in Germany has also been considered [Harthan et al. 2020].

Further details are documented in the following section 3.

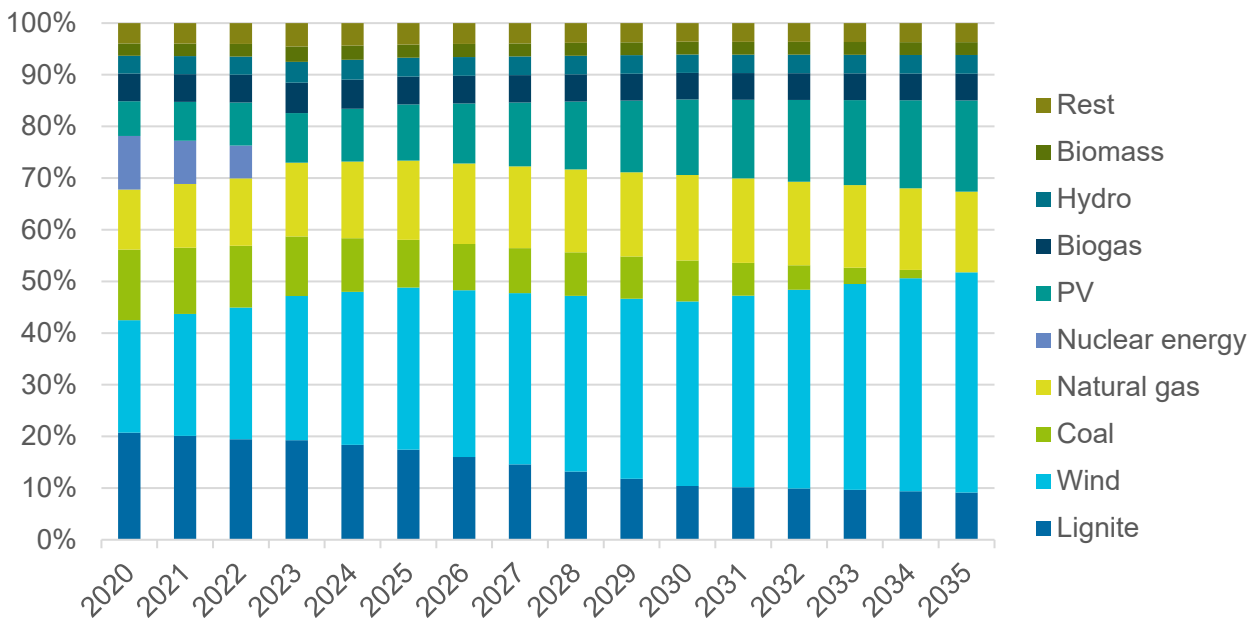
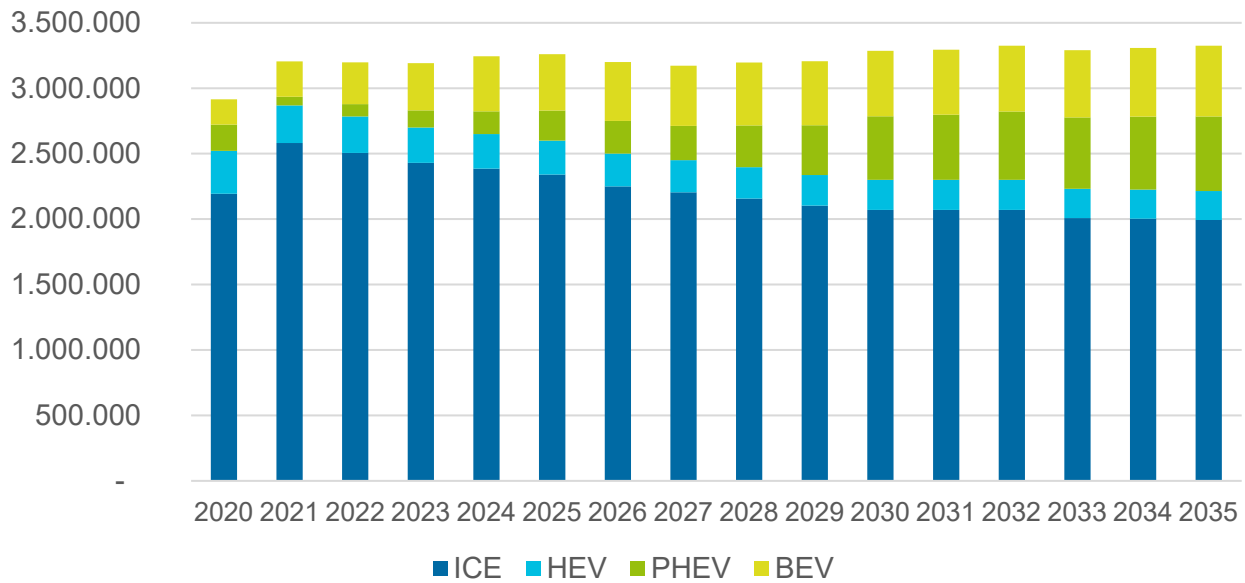

Figure 1 National electricity mix and development 2020 - 2035, data from Harthan et al., 2020

### 3 Scenario results on resource consumption

The following two figures show the development of newly registered passenger cars in Germany until 2035 for the Combustion<sup>4</sup> and the EV scenarios.

<sup>4</sup> For the Combustion Scenario, the numbers of newly registered passenger vehicles and the mix of the drive systems are based on the KSPr Scenario [Harthan et al. 2020]. For the EV Scenario, the data for different drive systems are based on the KN2050 Scenario [Langenheld et al. 2020] and the numbers of newly registered passenger vehicles are based on the KSPr Scenario [Harthan et al. 2020].



**Figure 2 Passenger vehicle sales in Germany, 2020-2035, under the Combustion Scenario, by drive system**

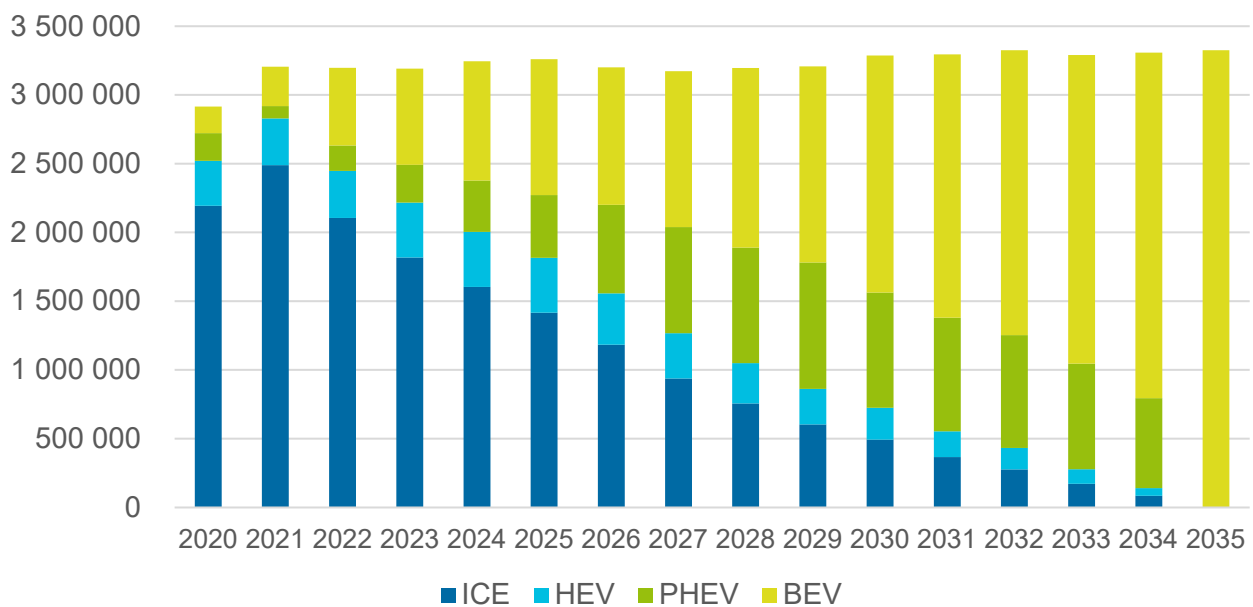

**Figure 3 Passenger vehicle sales in Germany, 2020-2035, under the EV Scenario, by power-train**

In the starting year 2020, a total of 2 917 348 passenger vehicles were registered in Germany [KBA 2021]. This figure must consider that 2020 was an unusually weak year for the passenger vehicle market because of the Corona pandemic. Thus, the decline in absolute registration figures compared to 2019 was 19.1 % [KBA 2021]. In 2020, the share of passenger cars with combustion engines (diesel or petrol) was approximately 75 %. HEVs follow, with 327 395 new registrations and a share of more than 11 %. Finally, PHEVs and BEVs fill the new car registrations in Germany with respectively 200 469 (almost 7 %) and 194 163 (significantly more than 6 %).

For both scenarios, it is assumed that the passenger vehicle markets will remain within their usual range in terms of absolute numbers until 2035.<sup>5</sup> As can be seen in Figure 2, for the Combustion Scenario the total share of HEVs, PHEVs and BEVs increases visibly until 2035. However, the share of newly registered passenger vehicles with strictly combustion engines (petrol or diesel) is still about 59 % (almost 2 million vehicles) in 2035. In the Combustion Scenario, however, the share of BEVs in 2035 is only 16 % (around 540 000 vehicles). In summary, in the Combustion Scenario electric mobility slowly gains market share, but passenger vehicles with petrol or diesel engines still dominating the market in 2035.

In the EV Scenario, on the other hand, it is assumed that the market ramp-up will be considerably steeper than in the Combustion Scenario. This applies to the market ramp-up of all-electric passenger cars, the BEVs. According to this scenario, almost 1 million BEVs can be expected to be registered annually in the passenger car sector in Germany as early as 2025. This already corresponds to a market share of around 30 % in 2025. In the EV Scenario, this steep market ramp-up of electric mobility would continue steadily until 2035. From that year onwards in this scenario, only BEV passenger vehicles would be sold in Germany.

The corresponding development of the passenger vehicle stock is displayed in the following Figure 4 and Figure 5. The model includes registrations of ICEs starting from 1990 and from other powertrains from 2009 onwards. In the starting year 2020, the model calculates a total stock of passenger vehicles amounting to ca. 48 million vehicles. According to the KBA, 48.2 million vehicles were registered as of 1 January 2021. Therefore, the calculated volumes are accurate.

In the Combustion Scenario the stock remains very stable regarding the share of ICEs reflecting the high sales. In 2025, 47.2 Million vehicles are in the stock with 4% of HEVs, 2% of PHEV and 3% of BEVs. In 2035 the total stock is in the same range composed of 72% ICEs, 7% HEVs, 10% PHEVs and 11% BEVs.

The EV Scenario development is much more dynamic. In 2025, the modelled stock is 46.75 million vehicles, comprising 85 % ICEs, 6 % HEVs, 4 % PHEVs and 5 % BEVs. The shift to electric powertrains dominates until 2035. Of the 45.6 million vehicles in 2035, only 36 % are ICEs, 7 % are HEVs and 17 % are PHEVs. The dominating powertrain is BEVs, with 39 % of the vehicle stock.

---

<sup>5</sup> As all vehicles, independent from their powertrain, lead to resource consumption and GHG emissions, a lower total number of vehicles would be favourable to achieve strong resource and energy savings. However, this is not part of this study, which only assesses the difference in resources between the chosen powertrains for two scenarios.

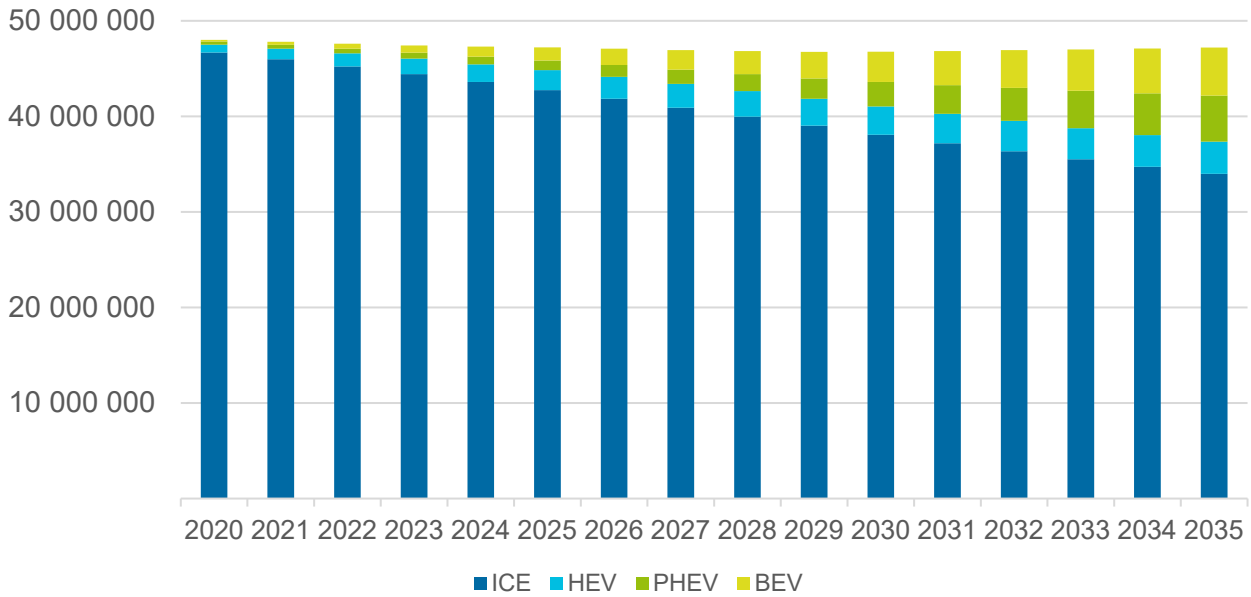

**Figure 4 Development of the passenger vehicle stock (Combustion Scenario)**

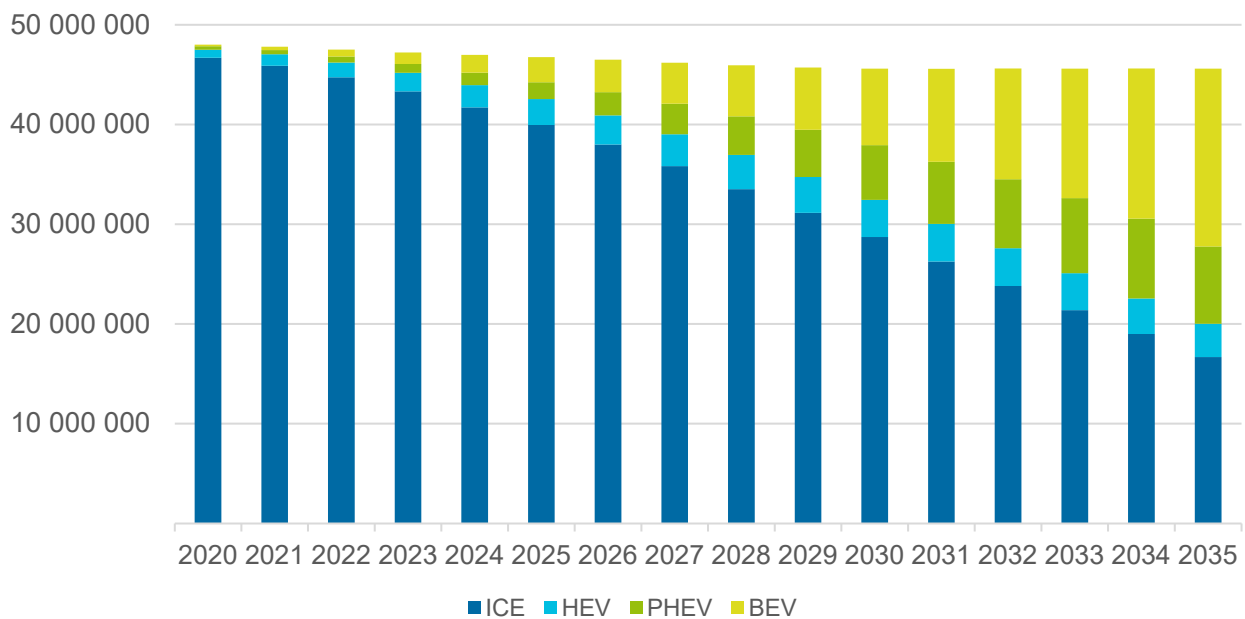

**Figure 5 Development of the passenger vehicle stock (EV Scenario)**

The strong differences between the two scenarios for Germany’s passenger vehicle sector in Germany serve the purpose of this paper to clearly elaborate the possible differences in the demand for various raw materials and the associated social and environmental impacts. The following subsections present and offer interpretations of the demand for raw materials in the two scenarios.

### 3.1 Raw material demand of petrol and diesel for passenger cars

Diesel and petrol are produced by distilling, cracking, and refining crude oil, a mixture of different hydrocarbons extracted from the earth’s crust. In addition to diesel and petrol, other products are also produced in the refining process, such as jet fuel for airplanes, naphtha for the chemical sector, and heating oil (see Figure 6), although petrol and diesel together account for more than half the

weight of petroleum refinery products in Germany [BMW 2019]. It is therefore difficult to exactly identify the amount of crude oil required to produce one litre of diesel or petrol. The refinement can be adjusted according to market demand for the different products, although this is combined with a certain effort in energy, catalysts and necessary infrastructure. For example, the US has a higher demand for petrol compared to diesel, and its refineries are more complex to be able to crack longer hydrocarbon chains into shorter ones for use as petrol instead of diesel. Nevertheless, the US also exports diesel to Europe, while Europe exports petrol to the US [BP 2019, Amec Foster Wheeler 2017]. Crude oil production and refining also consumes a considerable amount of energy, which was calculated by a well-to-tank (WTT) study (0.26 MJ and 0.24 MJ per MJ crude oil for diesel and petrol, respectively) [Prussi et al. 2020]. In this study, the amount of crude oil required for diesel or petrol only accounts for the energy lost through refinement as a rough estimate. Accordingly, this study assumes the factor of 1.26 L and 1.24 L of crude oil for 1 L of diesel and petrol, respectively.

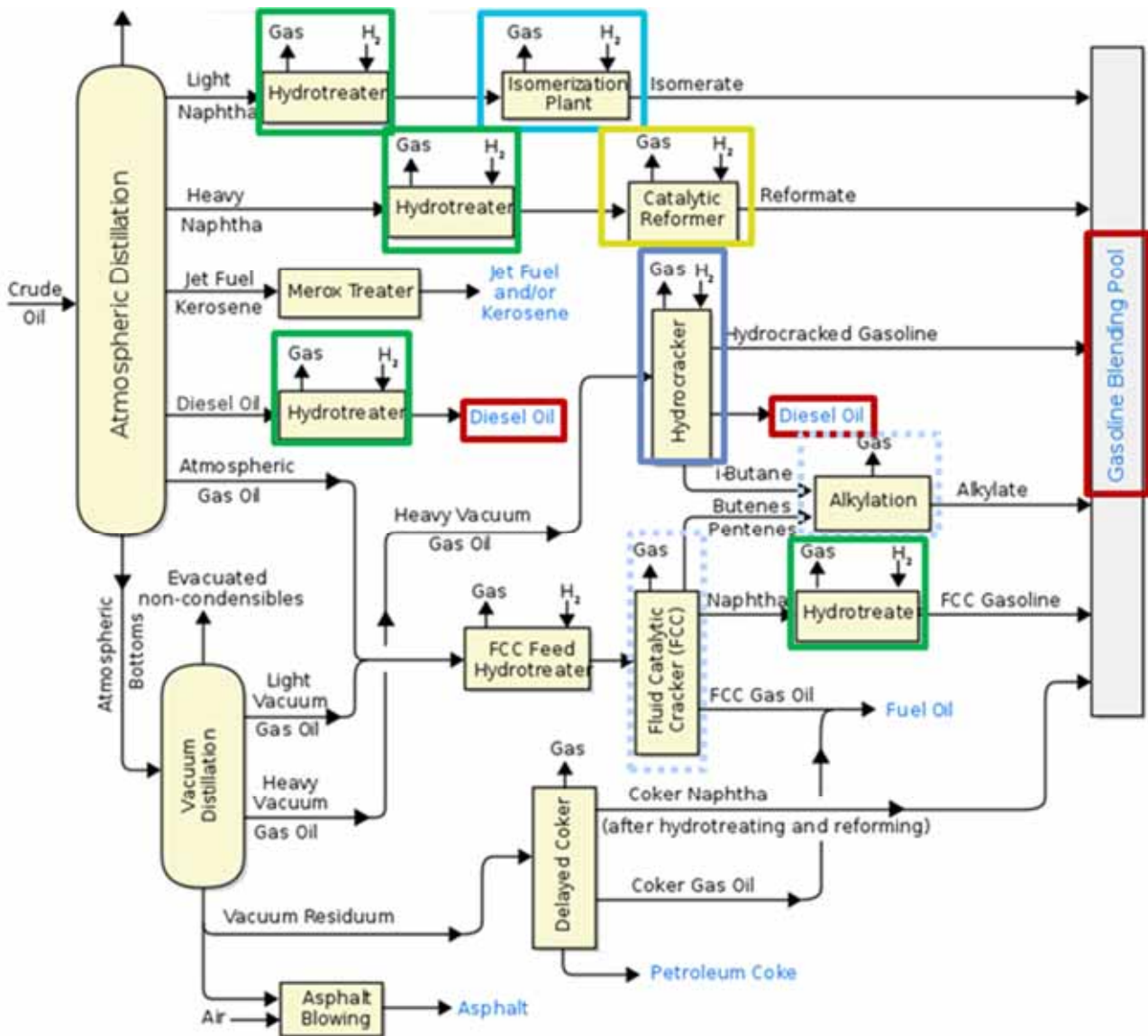
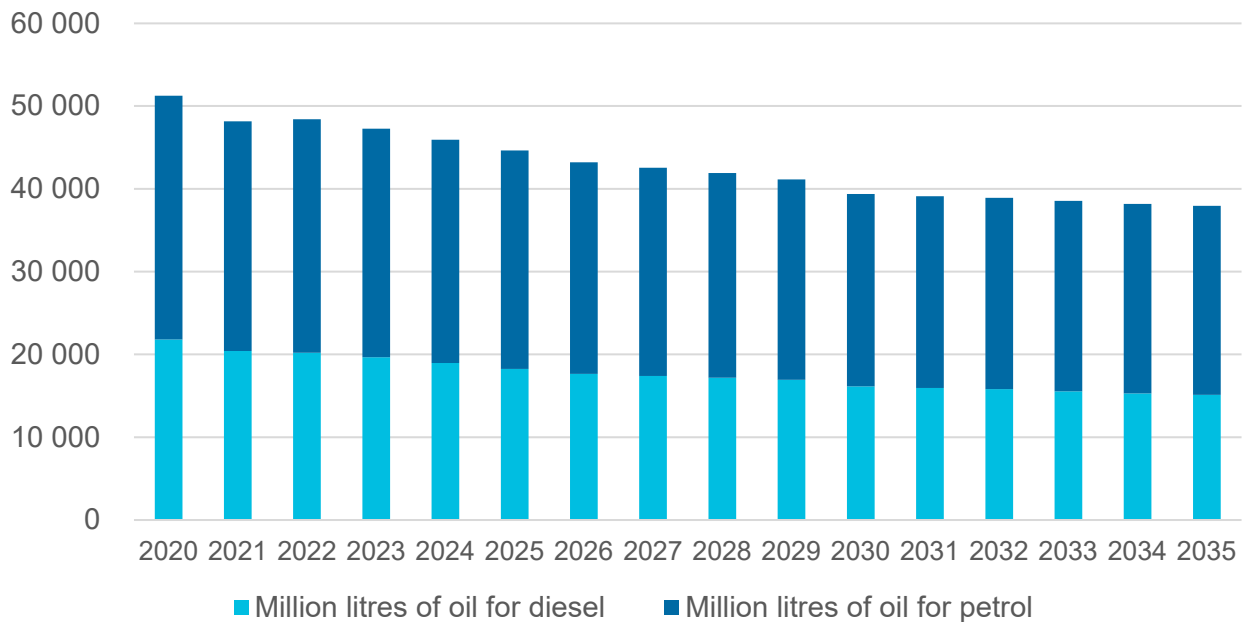

Figure 6 Scheme of an exemplary oil refinement process (omitting liquefied petroleum gas (LPG) for more clarity)<sup>6</sup>

<sup>6</sup> “Schematic process flow diagram of the processes used in a typical oil refinery”. by Mbeychok is licensed under CC BY-SA 3.0 (<https://commons.wikimedia.org/wiki/File:RefineryFlow.svg>) (21.01.2021)

With the aforementioned assumptions, the demand for crude oil for the passenger vehicle sector in Germany is calculated and depicted in Figure 7 and Figure 8. The amount of crude oil for each year calculated in our model considers the vehicle fleet in Germany and the average annual kilometres as well as average fuel economy (compare section 2.2). Other than the actual sales of vehicles, the impact of the Corona pandemic has not been accounted for in the model, e. g. the lower number of kilometres driven in 2020, which has probably led to an overestimation of fuel consumption in our model. Nevertheless, the value of about 51 billion litres of crude oil for the passenger car sector should be comparable to former years. The general demand for petrol is dominated by the passenger car sector, while more than half of diesel production in Germany goes to other means of transport such as trucks, trains, and ships [AG Energiebilanzen 2020].



**Figure 7 Crude oil demand in the Combustion Scenario, 2020-2035, in million litres of oil**

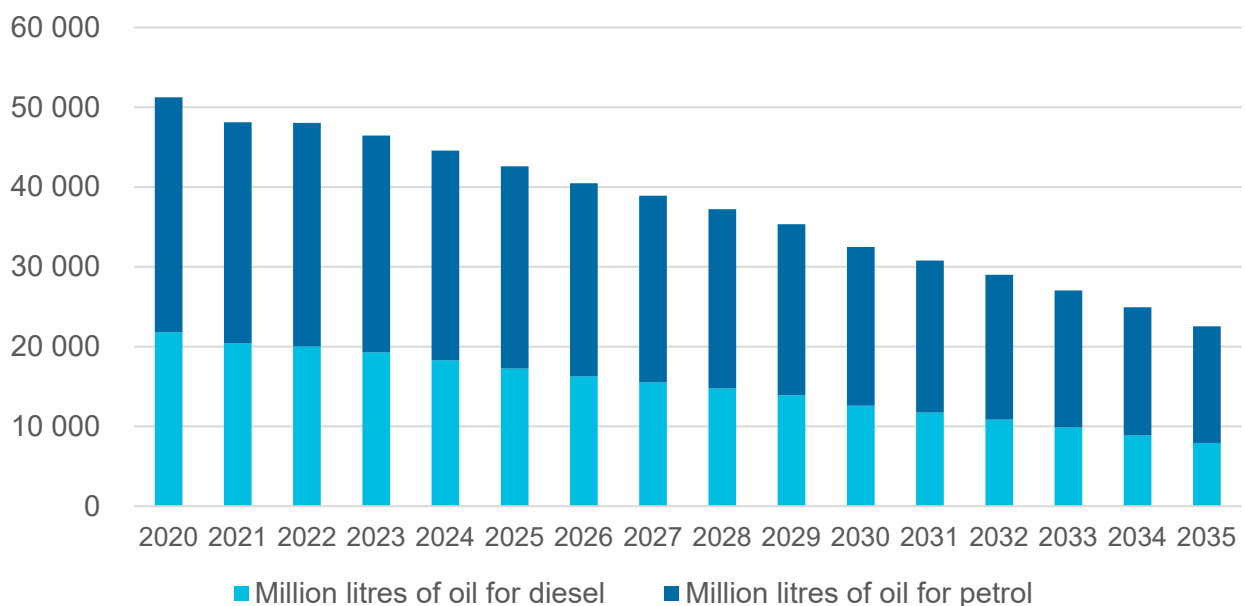

**Figure 8 Crude oil demand for fuel for passenger vehicles in the EV Scenario**



The demand for diesel and petrol from passenger vehicles declines in both scenarios (see Figure 7 and Figure 8) due to the assumed higher efficiency of combustion engines over the years and the increasing market share of electric mobility, whereby the decline is significantly greater in the EV Scenario. While in the Combustion Scenario crude oil consumption decreases by about 26 % in 2035 compared to 2020, in the same timeline in the EV Scenario, consumption decreases by nearly 56 %. If this drastic decline were to also play out in other industrialised countries, it would have a major impact on the crude oil industry and its production. Furthermore, the fuel demand in the EV Scenario in 2035 is almost half of the fuel demand in the Combustion Scenario.

As depicted in Figure 6, the refinement of crude oil is a complicated process, which requires not only energy and specific infrastructure but also catalysts. Different processes are relevant for the refinement of diesel and petrol which affect the demand for catalysts:

- Diesel is a mixture of hydrocarbons resulting mostly from the fractional distillery of crude oil and subsequent hydrotreating, although there are also several other processes in a refinery that can produce diesel fuel as a by-product. The amount of diesel produced from the other routes depends strongly on the type of crude oil (heavy to ultralight), the complexity of the refinement infrastructure, and also on the market demand. Therefore, it is nearly impossible to measure.
- Petrol production is even more complicated, as petrol is a mixture of different components that are produced in various processes. The petrol composition differs strongly depending on the refinery and the market situation. There are no current studies about the composition of petrol in Germany; the last one reports on composition from the year 2002 [DGMK 2003]. Compared to petrol production in 2002, the number of aromatic compounds is more restricted and the limit value for sulphur is lower, therefore changing the complete composition.

For assessing catalysts used, this study thus relies on two approaches:

- a bottom-up approach, using an exemplary study by Amec Foster Wheeler, which assumes an average refinement plant in the EU and calculates the results when an average mixture of crude oil is used to estimate the ratio of catalysts for the production of petrol and diesel compared to the whole refinement industry [Amec Foster Wheeler 2017] and
- a top down approach, approximating the amount of catalysts used in current petrol production by calculating Germany's share of catalysts out of the general, worldwide consumption of catalysts for refinement<sup>7</sup> [ENI 2020, BMWI 2019].

As it was not possible to find any reliable source about the amount of palladium, nickel or tungsten used in crude oil refinement, since indeed their amounts do not seem to play a role for the market demand as a whole, these elements were omitted from our calculations and it was assumed that only platinum/rhenium and molybdenum/cobalt catalysts play a significant role for crude oil refinement.

Platinum and rhenium are both used together as a catalyst for the catalytic reforming of naphtha. Furthermore, platinum is also used for isomerization of naphtha. Both processes lead to components used in petrol. Based on our own calculations, petrol production contributes to about 55 % of platinum demand in the petrochemical industry in Germany. Nevertheless, the amounts are more than one hundred times lower compared to the platinum group metals (PGMs) necessary for automotive catalysts (see section 3.2).

---

<sup>7</sup> Pt: [JM 2020]; Re: [USGS 2020 A], [USGS 2017]; Mo: [IMOA 2020]; Co: [Darton Commodities 2020] and own assumptions.



One reason is the high recycling rate and the different basis for the calculation, as for platinum and rhenium as industrial catalyst, the net demand has been used. As the recycling rates are high (over 90 %) and the consumption during use is only about 10 % of the platinum catalyst, this decreases the platinum amount required each year. Since the European refinery market is also no longer growing, a large proportion of industrial platinum catalysts can be produced from secondary material leading to a low net demand.

As the demand for petrol and diesel in the model decreases, the amount of catalysts needed accordingly decreases for all the industrial catalysts in the same order of magnitude. Since the fuel demand in the Combustion Scenario is about twice as high as in the EV Scenario, the demand for catalytic converters is also twice as high for all catalysts (see Figure 9, Figure 10, Figure 11 and Figure 12).

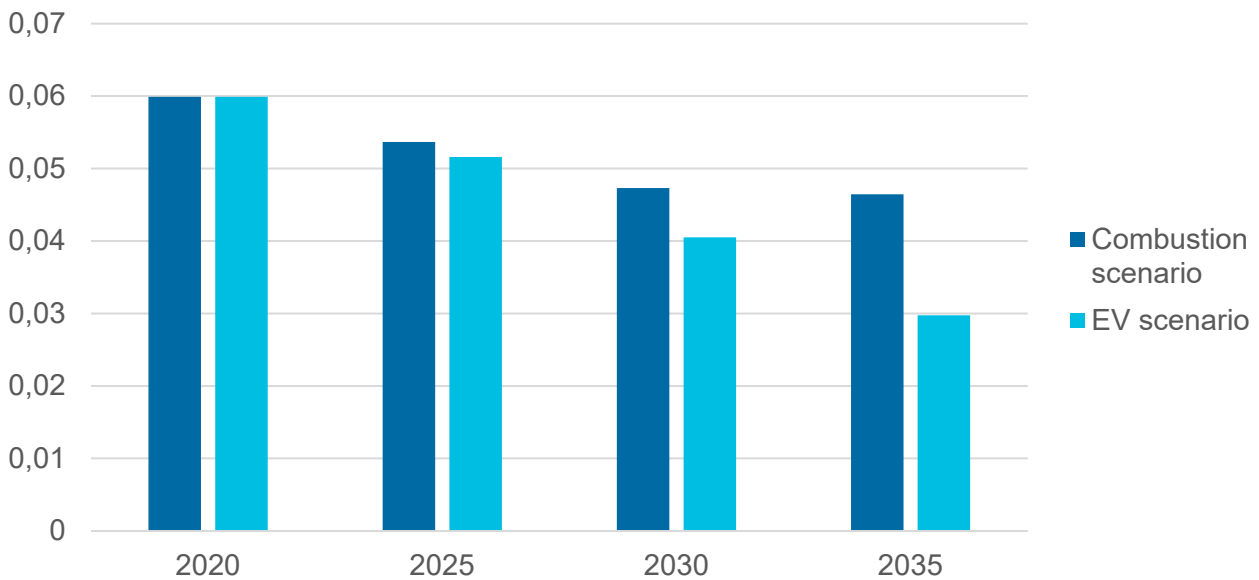

Figure 9 Platinum net demand for oil refining catalysts, in tonnes per year

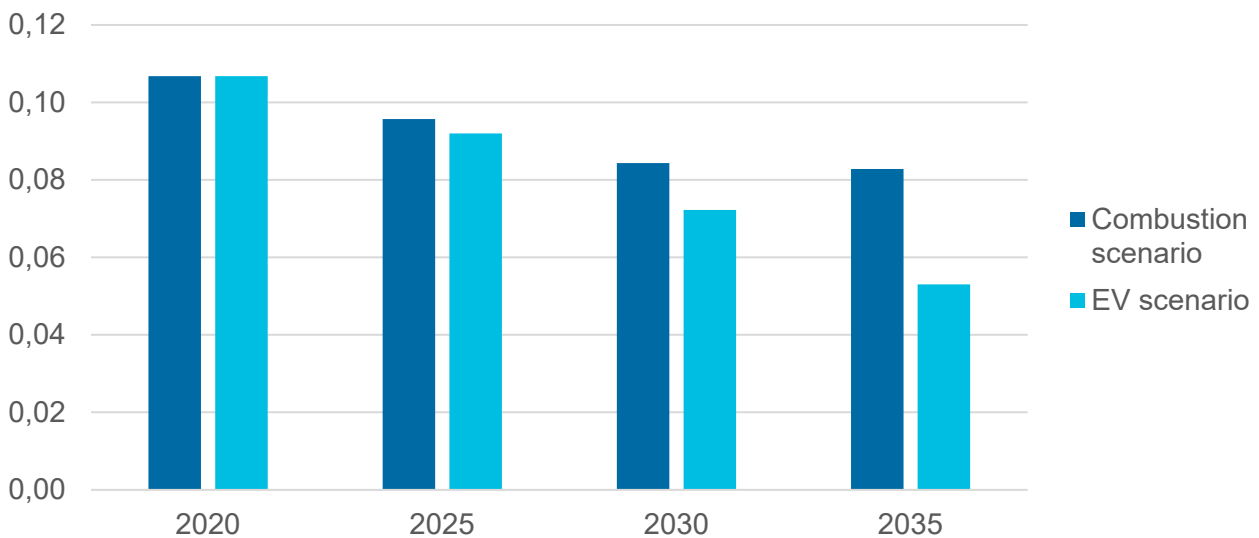

Figure 10 Rhenium net demand for oil refining catalysts, in tonnes per year

Molybdenum and cobalt are used together as a catalyst in the hydrotreatment of crude oil to remove sulphur, as it poisons PGM catalysts (during refinement and in exhaust gas purification in vehicles). There is also a legal limit for sulphur content in the EU of 0.01g of sulphur per kg of diesel or petrol. The demand for molybdenum and cobalt is calculated in the same way as for platinum and rhenium. However, it is much higher, as the catalysts need more of the metal and the hydrotreatment must be conducted over the whole production process of petrol and diesel and not just parts of the process. Furthermore, the recycling rates are lower. There are no current studies about the recycling of Mo/Co catalysts. But as the prices for these metals are low in 2020, the rates also declined – a trend confirmed by stakeholders from the catalyst recycling sector.

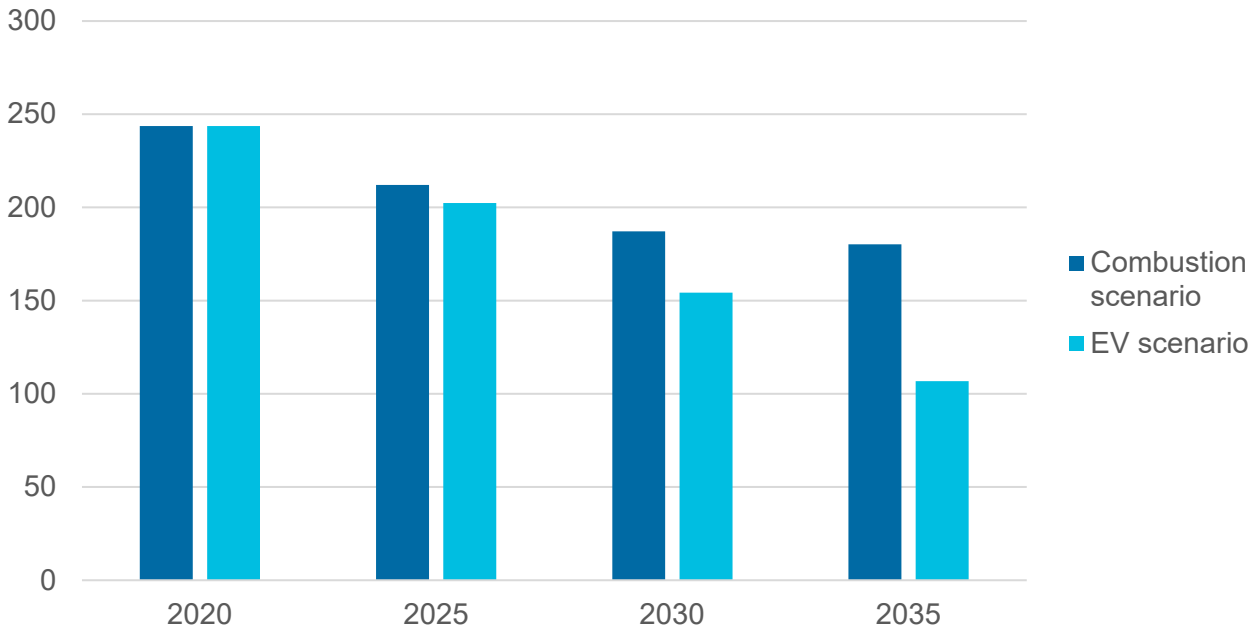

Figure 11 Molybdenum net demand for oil refining catalysts, in tonnes per year,

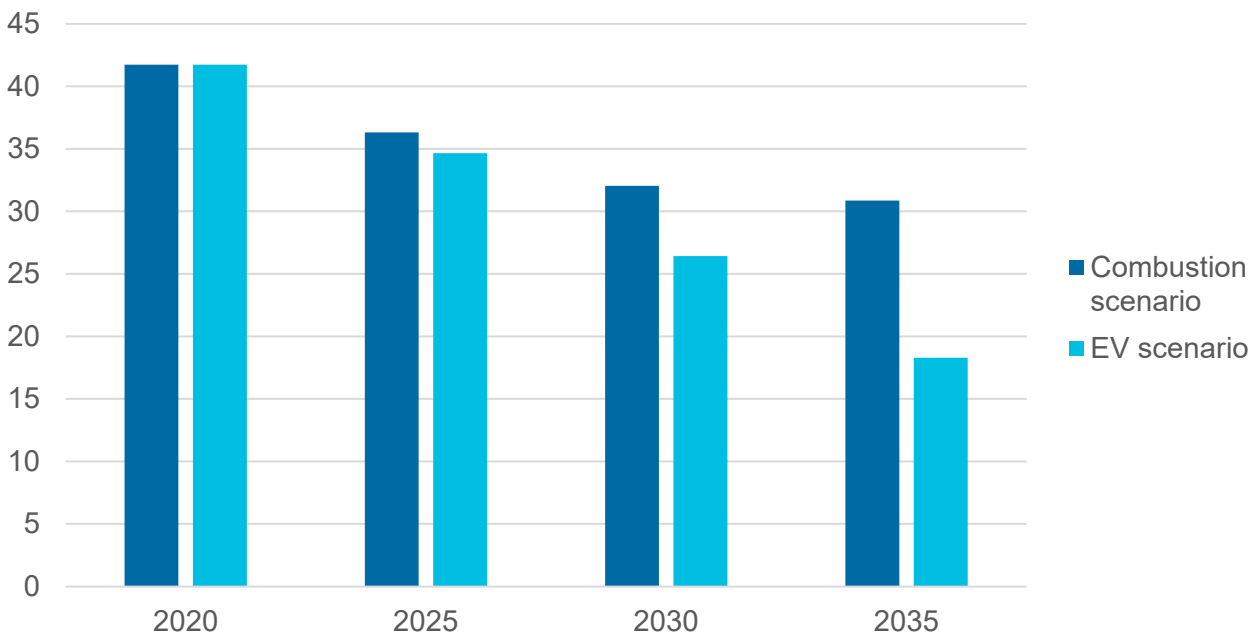
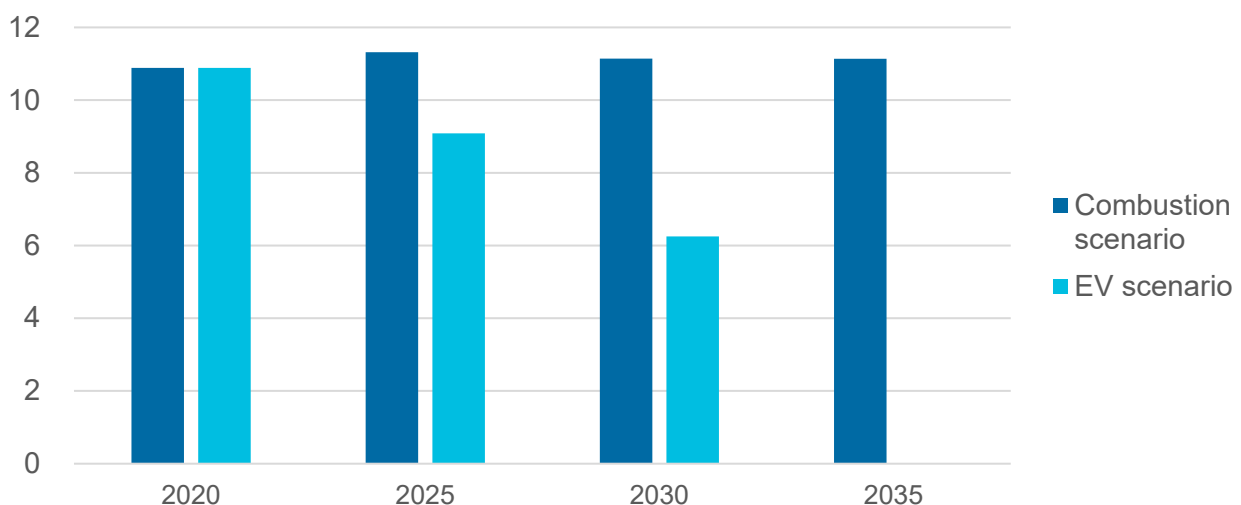

Figure 12 Cobalt net demand for oil refining catalysts in tonnes per year

Putting the values for the different metals into perspective, the consumption of catalysts for crude oil refinement accounts for a relevant share of the world market with about 7 % of molybdenum, 7 % of rhenium, 2 % of cobalt and 3 % of platinum, not accounting for use in other catalytic processes.<sup>8</sup>

### 3.2 Raw material demand for automotive catalysts

Platinum group metals are indispensable for automotive catalysts to reduce air emissions of nitrogen oxides, carbon monoxide and particles in the exhaust gases of cars with combustion engines. Depending on the type of passenger vehicle (petrol or diesel engine, etc.), the platinum group metals platinum, palladium and rhodium are used in varying proportions for the catalytically effective coatings in the catalytic converters. In the scenarios, a total of 4g of platinum group metals (PGMs) are included for each passenger vehicle with an internal combustion engine [SubSKrit 2019]. The following graph shows the development of the annual PGM demand of the passenger vehicle sector in Germany from 2020 to 2035 according to both scenarios. Based on slightly over 10 tonnes of total PGM demand in the starting year 2020, the annual demand in the Combustion Scenario rises moderately to just above 11 tonnes. In the EV Scenario, on the other hand, the increasing market ramp-up of BEVs already reduces PGM demand to six tonnes per year by 2030. In 2035, according to this scenario, no more PGMs will be needed for the passenger vehicle sector in Germany, as only BEVs will enter the market. It is important to mention that mature recycling structures exist for the valuable PGMs from automotive catalysts but also from other application areas. For 2018, 44 % of platinum, 30 % of palladium and 39 % of rhodium are reported as secondary metals in the automotive catalytic converter sector. These shares have risen steadily over the last 20 years due to the input of end-of-life vehicles into the circular economy [Hagelüken 2020].



**Figure 13 PGM demand for catalysts, in tonnes per year**

The rare earth metal cerium is still relevant for automotive catalysts. It is incorporated in the form of cerium (IV) oxide as a component of the ‘washcoat’ and sustainably supports the efficiency of automotive catalysts [Bleiwas 2013]. The average content of cerium per unit is 65g (calculated as cerium metal). In contrast to PGMs, recycling of cerium from automotive catalytic converters has not yet taken place [Bleiwas 2013], not least because cerium is one of the cheapest metals in the rare earth metal family [Schueler et al. 2011].

<sup>8</sup> Pt: [JM 2020]; Re: [USGS 2020 A], [USGS 2017]; Mo: [IMOA 2020]; Co: [Darton Commodities 2020] and own assumptions

The following graph shows the development of cerium demand for automotive catalysts between 2020 and 2035 for both scenarios. As can be clearly seen in the diagram, in the Combustion Scenario cerium demand changes only insignificantly between 2020 and 2035 (approx. 180 tonnes of cerium demand each year). In the EV Scenario, on the other hand, cerium demand declines sharply; in 2030, only 100 tonnes of cerium are expected to be needed for automotive catalysts. Cerium demand continues to decline to zero in 2035, reflecting the steep growth in the market share of BEVs in this scenario.

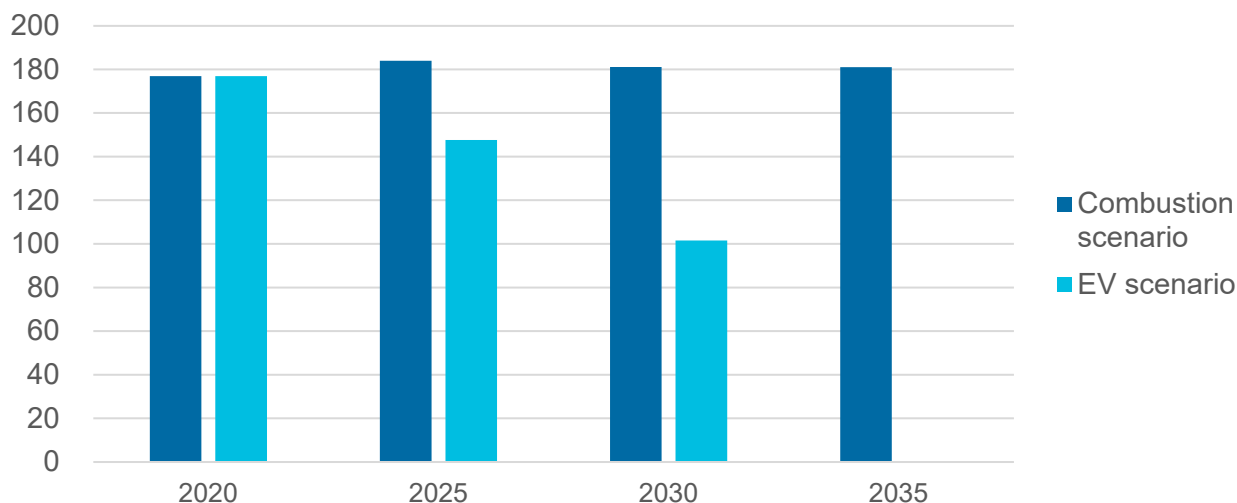

Figure 14 Cerium demand for catalysts, in tonnes per year

### 3.3 Raw material demand for traction batteries and electric motors

Lithium-ion traction batteries and electric motors are by far the most important key components of electric vehicles. This sub-section therefore looks in detail at the material and raw material requirements that are expected to be needed for LIBs (traction batteries) and electric motors between 2020 and 2035 depending on the scenario. Figure 15 shows the development of the total demand for lithium-ion batteries for the passenger car sector in Germany until 2035. The data for the material and raw material requirements for lithium-ion batteries (LIBs) are based on information from Stahl et al. [2021].

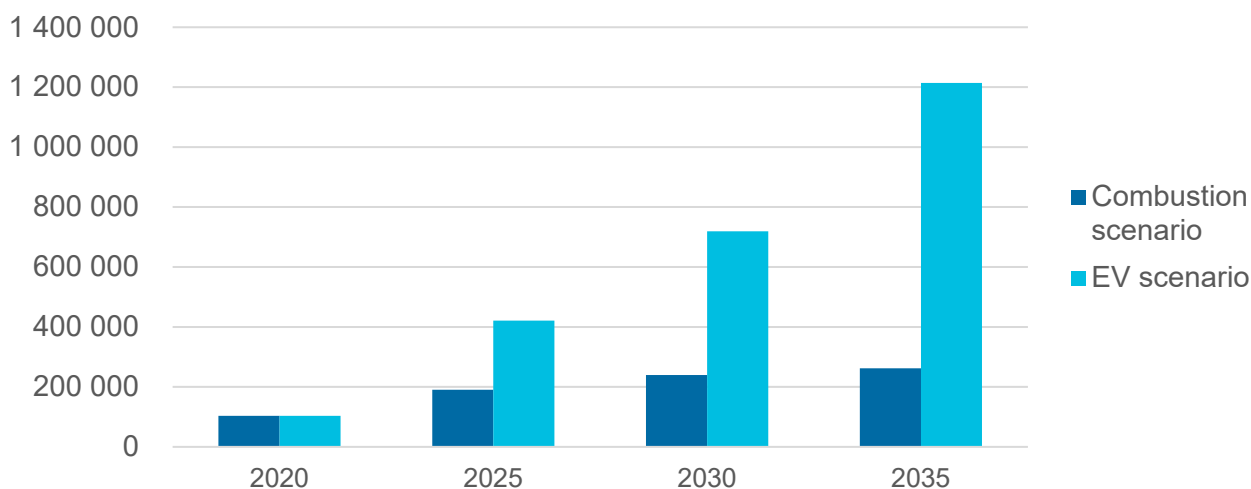
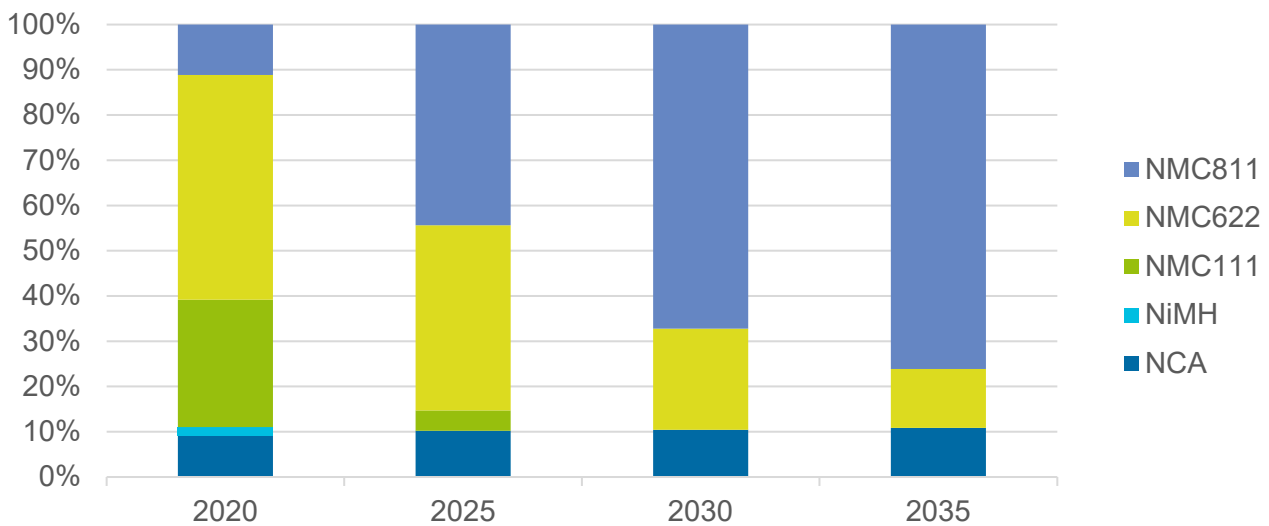

Figure 15 Demand for LIB per scenario, in tonnes

In Figure 15, the market ramp-up of electric mobility is clearly visible as the demand for lithium-ion batteries (entire battery packs). In the Combustion Scenario, the annual demand for LIBs in Germany for the passenger car sector grows from about 100 000 tonnes in 2020 to 190 000 tonnes in 2030 and 262 000 tonnes in 2035. In the EV Scenario, the market ramp-up of electric vehicles and thus the demand for LIBs is considerably steeper. In the EV Scenario, about 720 000 tonnes of LIBs will already be in demand in 2030. From 2035 onwards, this will be 1.21 million tonnes (only BEVs will enter the passenger car market in Germany). Since it is also assumed for the EV Scenario that around 3.32 million new passenger vehicles will be registered in Germany, it can also be assumed that the annual maximum demand for LIBs for passenger cars will be reached in 2035.

The following graphs show the effects of the two passenger vehicle scenarios on the demand for key raw materials in lithium-ion batteries (LIBs), covering scenario results for lithium, cobalt, nickel, copper, and graphite. For scenario modelling, foreseeable or already implemented developments are considered [Stahl et al. 2021, Argonne 2020]. This applies in particular to the trend towards cobalt-poorer and at the same time nickel-rich cathode compositions for LIBs (compare Figure 16).



**Figure 16 Current development trend for cell chemistries in traction batteries placed on the market between 2020 and 2035 [based on own estimations]**

The current trends in cathode materials for the lithium-nickel-manganese-cobalt-oxide (NMC) cell chemistry, which is dominant for passenger cars, is clearly moving from NMC111 via NMC622 to NMC811. The figures largely correspond to the ratios of nickel, manganese, and cobalt in percent by weight. The assumptions regarding cell chemistries do not differ in the two scenarios.

However, possible disruptive developments, such as the oft-discussed solid-state batteries, are not considered, as it is not yet foreseeable whether or when these new batteries will actually be available for the mass market passenger vehicle sector.

The following Figure 17 shows the development of lithium and cobalt demand of LIBs for both passenger vehicle scenarios for the years 2020, 2025, 2030 and 2035. The annual lithium<sup>9</sup> demand from the passenger car sector in Germany increases in the Combustion Scenario from around 2 200 tonnes in 2020 to slightly over 5 400 tonnes in 2035. In the EV Scenario, on the other hand, annual lithium demand rises to about 24 200 tonnes by 2035. For cobalt, annual demand in the Combustion

<sup>9</sup> Note: the lithium demand in tonnes refers to the lithium metal content in the batteries. The figures should therefore not be confused with lithium carbonate equivalent (LCE) data. The reference value LCE is often used in connection with statistics on primary lithium extraction.

Scenario rises moderately, from just under 4 000 tonnes in 2020 to about 4 900 tonnes in 2035. In the EV Scenario, on the other hand, the annual demand for cobalt is around 21 200 tonnes. In comparing the annual development of lithium and cobalt, it can be noted that the total percentage increase between 2020 and 2035 in the EV Scenario is 1.090 % for lithium, and 534 % for cobalt. This discrepancy emphatically reflects the development towards batteries containing less cobalt.

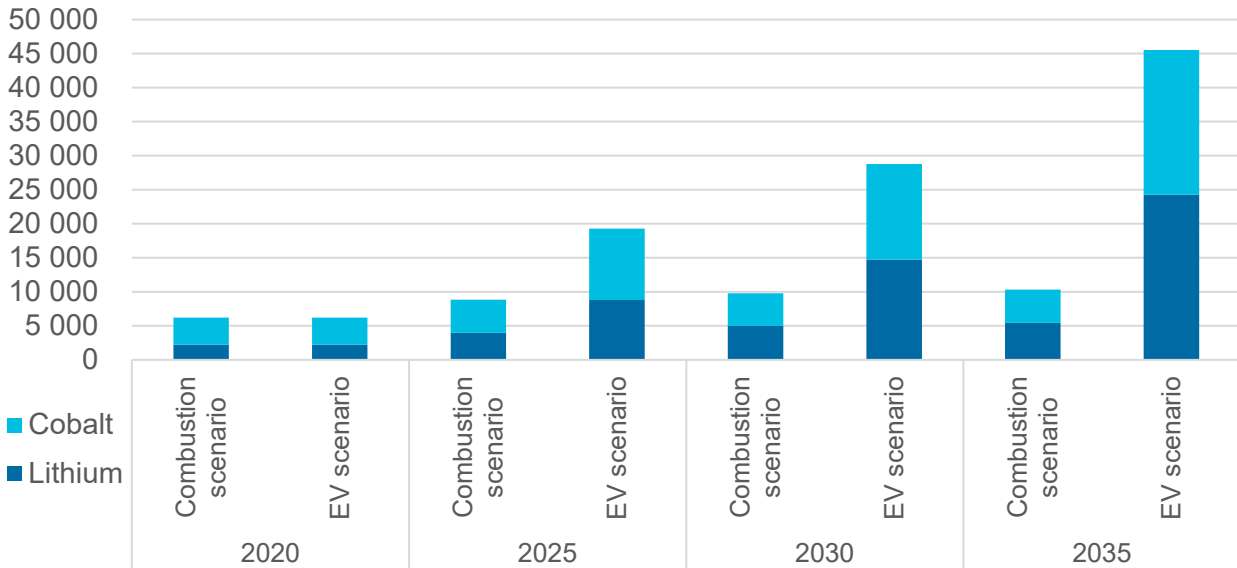

**Figure 17 Cobalt and lithium demand for traction batteries, per model scenario, in tonnes**

Figure 18 shows the developments in demand for the key metals nickel and copper for both scenarios. Once again, the increases in demand are visible in the Combustion Scenario but moderate for the EV Scenario. In the case of nickel, annual demand rises from about 9 500 tonnes in 2020 to almost 141 500 tonnes in 2035 in the EV Scenario, which corresponds to a total percentage increase of almost 1 500 %. This reflects the trend towards nickel-rich NMC variants when contrasted with the increase in demand for cobalt, which “only” amounts to 534 %. Nickel is thus the fastest-growing key element in lithium-ion batteries. The annual demand for copper for LIBs will also increase considerably: from almost 15 700 tonnes in 2020 to around 209 000 tonnes in 2035, or by about 1 300 %.

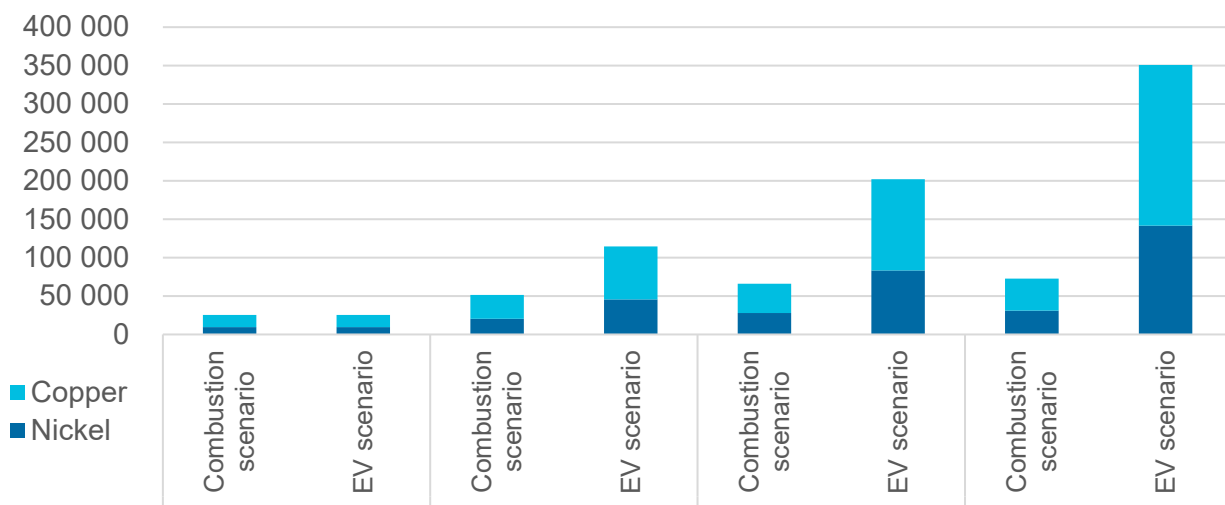

**Figure 18 Copper and nickel demand for traction batteries, per model scenario, in tonnes**

Figure 19 below shows the development of demand for graphite for both scenarios. Graphite is by far the most important anode material for LIBs. For graphite, too, the Combustion Scenario shows a

clear growth in annual demand until 2035, whereas the EV Scenario shows rapid growth from around 15 000 tonnes (2020) to about 192 000 tonnes (2035).

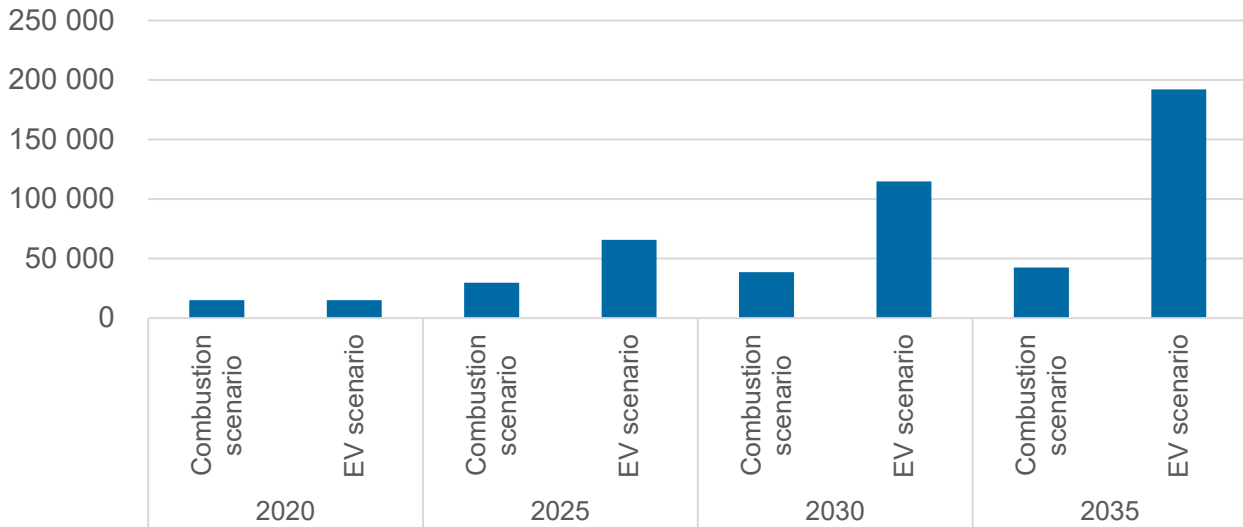

**Figure 19 Graphite demand for traction batteries per scenario, in tonnes**

In addition to the lithium-ion battery, the electric motor is a central component of electric vehicles<sup>10</sup>, which is not relevant in vehicles that only have a powertrain with an internal combustion engine. For the powertrain of electric vehicles, car manufacturers use different electric motors in their various models. In the resource debate, electric motors are primarily addressed in reference to permanent magnet synchronous motors (PSM) since these electric motors are equipped with permanent magnets based on neodymium iron boron magnets (NdFeB). NdFeB magnets contain around 30 % by weight of rare earth elements: the light rare earth elements neodymium and praseodymium and the heavy rare earth elements dysprosium and terbium. Dysprosium and terbium are relevant for stabilising the magnetic function of the PSM even at higher temperatures, an important role for use in electric vehicles [Schueler et al. 2016].

Other types of electric motors operate without permanent magnets: electrically excited synchronous motors (EESM) and asynchronous motors. These electric motors, which do not require rare earth elements, in turn require significantly more copper than the PSM. All electric motors for passenger vehicles contain copper and/or rare earth elements. In addition to copper and/or permanent magnets containing rare earth elements, all electric motors for passenger cars mainly contain components made of steel and aluminium [Schueler et al. 2016, Buchert et al. 2011, Bast et al. 2014].

HEVs and PHEVs generally use PSMs that contain NdFeB magnets with rare earth elements. The lighter and smaller PSMs are necessary here because the additional combustion drive in HEVs and PHEVs requires additional installation space. In BEVs, on the other hand, there are different types of electric motors, depending on the manufacturer and model<sup>11</sup>. For the scenario modelling, the percentage distribution of the different types of electric motors was based on Falkenberg et al., 2019. The details of the quantity inputs of the different rare earth elements and the future change in these ratios are based on data from SubSKrit 2019. The data on the inputs of copper, aluminium and steel were compiled from various other sources [Buchert et al. 2011, Bast et al. 2014].

<sup>10</sup> In passenger vehicles, models equipped with several electric motors can be found, especially in the premium segment.

<sup>11</sup> For the scenarios, 100 % PSM is used for PHEVs and HEVs, and 50 % PSM for BEVs.

The following Figure 20 shows the volume development of demand for rare earth elements (REE) for NdFeB magnets (representing ca. 30 % by weight of the total magnet) for both scenarios. Starting from around 320 tonnes in 2020, the annual demand in the Combustion Scenario increases to around 660 tonnes. In the EV Scenario, on the other hand, the annual demand for REE for NdFeB magnets grows to just under 1 300 tonnes by 2030 and then moderately declines to just under 1 200 tonnes annually by 2035. This is because, in the EV Scenario, only BEVs will be newly registered in the passenger car market in Germany in 2035. As explained above, BEVs use electric motors without NdFeB magnets in several models – in contrast to PHEVs and HEVs.

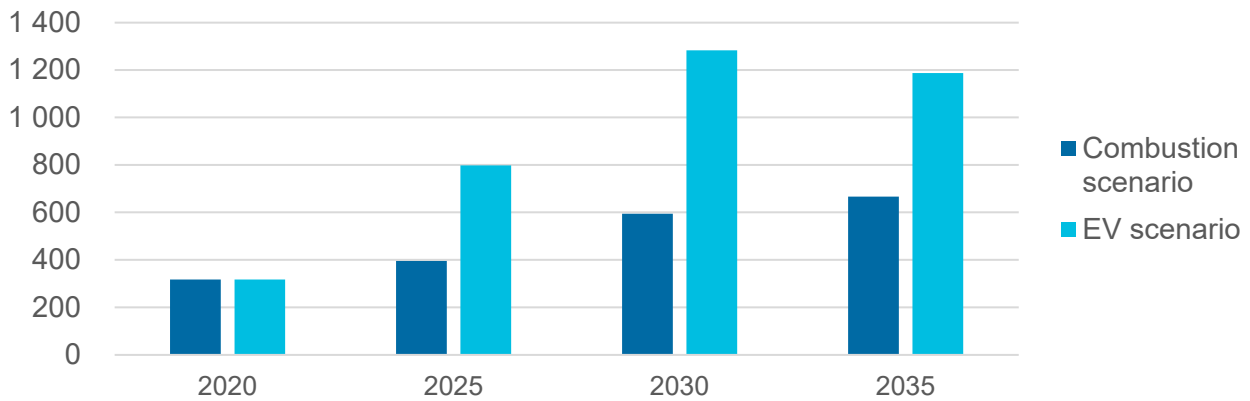

**Figure 20 REE demand for NdFeB magnets demand for electric motors, in tonnes of metals**

The annual copper demand for the electric motors of the passenger car market in Germany (Figure 21) grows in the Combustion Scenario from around 9 100 tonnes in 2020 to approximately 28 100 tonnes in 2035. In the EV Scenario, on the other hand, the corresponding copper demand in 2035 is just under 86 200 tonnes. Nevertheless, copper demand for lithium-ion batteries is significantly higher, about 209 300 tonnes in 2035 under the EV Scenario.

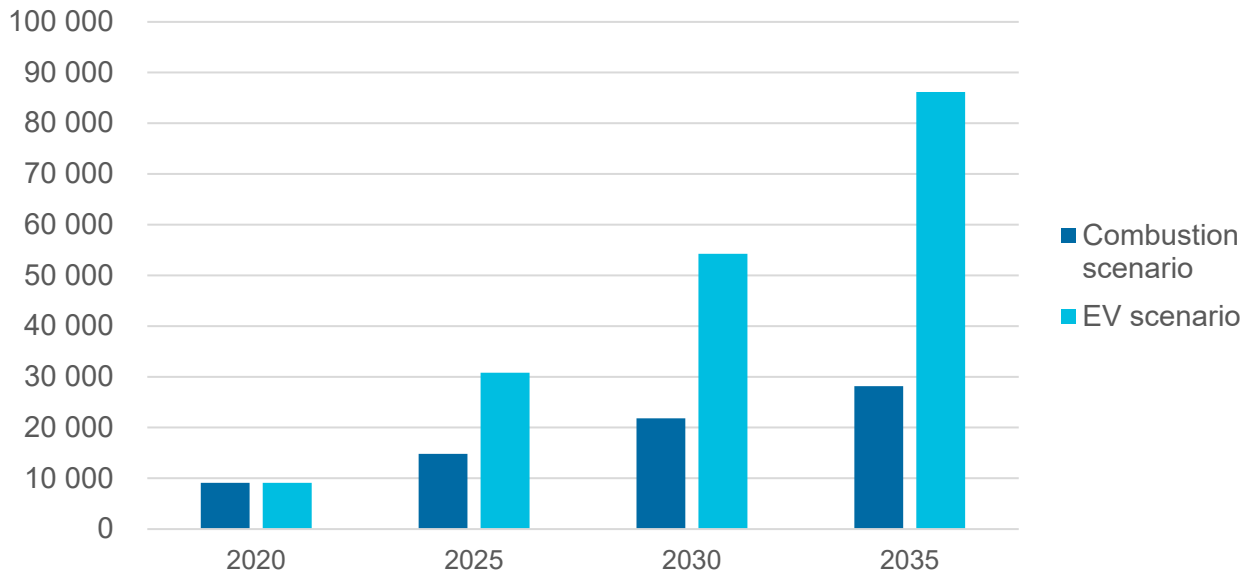

**Figure 21 Copper demand for electric motors per scenario, in tonnes of metal**



### 3.4 Raw material demand for additional wind power and PV infrastructure (national electricity mix)

In modelling the raw material requirements of the development of the passenger car sector in Germany, the raw material requirements for the necessary infrastructure for the additional installation of renewable energies and the additional demand for fossil energy sources in the electricity mix were also balanced for the two scenarios. Both scenarios are based on the expected development of the national electricity mix between 2020 and 2035 (cf. subsection 2.2). Only the necessary additional electricity demand for the additional electric vehicles is considered as a significant variable. The raw material demand for nuclear energy in the German electricity mix (uranium, etc.) was neglected in the model, as the last nuclear reactors in Germany are planned to be decommissioned by the end of 2022, according to legislative decisions. The infrastructure requirements for coal and natural gas power plants were also neglected for the scenarios due to their declining importance as a result of the energy transition. To balance the raw material requirements for the additional wind power and PV plants, current data from the Joint Research Center (JRC) about the future expansion of various technology types for both wind power and PV were taken into account [JRC 2020].

The shares of the respective subtypes for wind power and PV as well as the allocable material requirements are all based on the JRC's HDS (High Demand Scenario) [JRC 2020]. The JRC describes and balances four relevant subtypes for wind turbines:

- DD-EESG            Direct drive – Electrically excited synchronous generator,
- DD-PMSG        Direct drive – Permanent magnet synchronous generator,
- GB-DFIG         Gear box – Double-fed induction generator,
- GB-PMSG        Gear box – Permanent magnet synchronous generator.

All of these four wind turbine subtypes contain rare earth elements (REE) in NdFeB magnets. However, GB-DFIG contains only very small amounts of REE; the subtypes DD-EESG and GB-PMSG contain amounts in the medium range; and DD-PMSG contains large amounts of REE per MW of capacity.<sup>12</sup> DD-PMSG has a very high market share, especially for offshore wind turbines. Based on JRC 2020, the scenarios for this subtype include growing market shares from 2020 (72 %) to 2035 (86 %) in the offshore market.

Figure 22 shows the cumulative rare-earth-element (REE) demand for both scenarios, which is required between 2020 and 2035 as part of the additional wind power capacity needed for passenger cars with electric powertrains. In the Combustion Scenario, the cumulative demand for REE for additional wind power capacities is around 290 tonnes. In the EV Scenario, the stronger increase in electricity demand for electric vehicles is reflected in a cumulative demand for REE of slightly more than 900 tonnes. Since the REE share of NdFeB magnets is around 30 % by weight, the cumulative material demand for NdFeB magnets is in the order of 3 300 tonnes. Comparing this cumulative figure with the annual demand for NdFeB magnets for electric motors in the passenger car sector in Germany indicates that the demand for 2035 alone, for example, is already higher, at almost 4 000 tonnes for the EV Scenario. In other words, the material requirement for the additional wind power capacity, although not negligible, is of significantly less importance (less than factor 10) compared to the requirement for the vehicular component (i.e. the electric motor).

---

<sup>12</sup> For details see [JRC 2020].

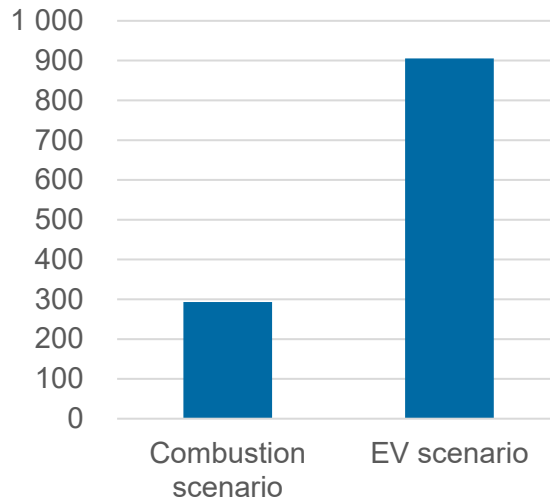

**Figure 22 Cumulative REE demand for additional wind turbines for EVs between 2020 and 2035, in tonnes (national electricity mix)**

Different types of solar cells are available for generating electrical energy through photovoltaics (PV). According to JRC 2020, the current market share of thin-film cells within the PV market is still around 4.6 %. However, based on figures from JRC's HDS Scenario, these market shares could grow to as much as 15 % by 2035 (compare values in Figure 23). Within the group of thin-film cells, three sub-types are distinguished:

- CdTe Cadmium telluride,
- CIGS Copper indium gallium di-selenide,
- a-Si Amorphous silicon.

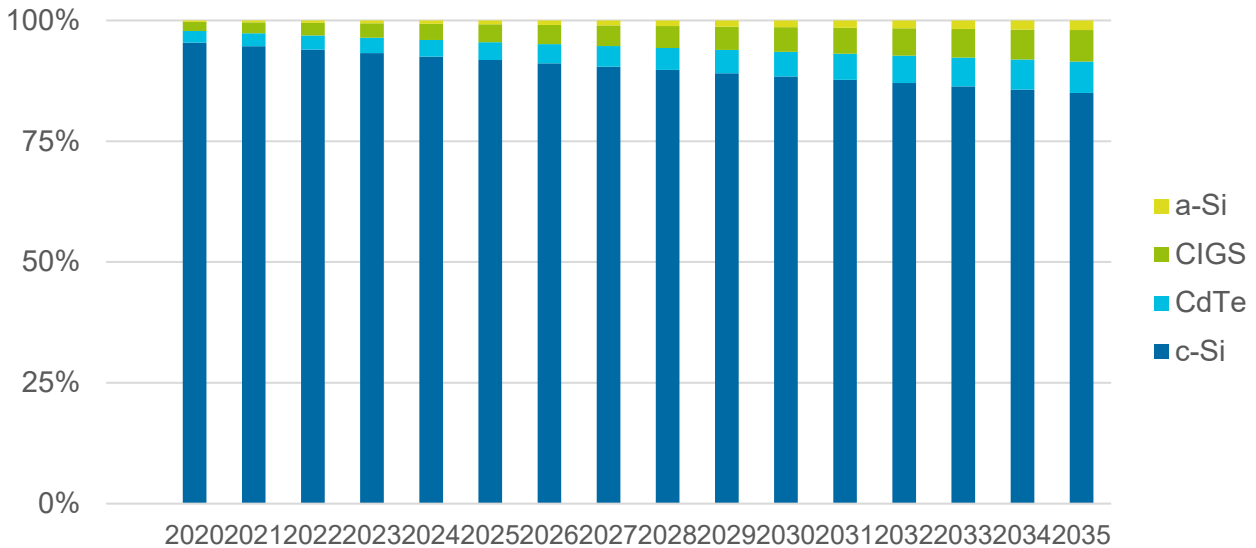

**Figure 23 Market share of different PV types between 2020 and 2035**

According to data from JRC 2020, CIGS cells currently have a market share of only 1.9 % in the PV market. However, this could increase significantly to 6.5 % by 2035. CIGS cells contain several ‘technology metals’ such as indium, gallium, and selenium, which are of interest from a raw material supply perspective.

The scenario results for the technology metal indium are shown in Figure 24 below. In the Combustion Scenario, only 2.5 tonnes of indium are required over the entire scenario period for the proportionate additional demand for CIGS cells for the additional electric vehicles in the German passenger car market. In the EV Scenario, the corresponding value is 7.7 tonnes. According to USGS 2020 A, global refined indium production was 760 tonnes for 2019 alone, whereas the cumulative demand (2020 to 2035) for indium in the EV scenario is relatively insignificant.

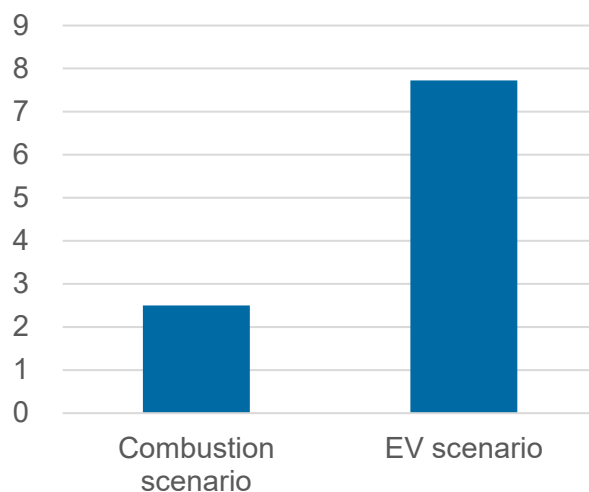

**Figure 24 Cumulative indium demand for additional PV systems for EVs between 2020 and 2035, in tonnes (national electricity mix)**

It is important to mention that, in the PV sector, the use of relatively expensive technology metals such as indium is being continuously reduced through innovations to reduce the manufacturing costs per unit. For example, the JRC assumes that the specific use of indium in CIGS will be approximately halved by 2035. These tendencies are also a clear trend for the other technology metals in CIGS and also in the other thin-film solar cells. The specific raw material input in this sector will therefore continue to fall significantly in the coming years.<sup>13</sup>

Capturing by far the largest market share in the PV sector is crystalline silicon (c-Si) solar cells [IZT/OEKO 2019]. The JRC currently indicates a market share of around 95.4 %, which may decrease moderately to 85 % by 2035 [JRC 2020]. Figure 25 shows the cumulative crystalline silicon demand for the additional silicon solar cells required between 2020 and 2035 for the two scenarios. The Combustion Scenario results in a cumulative demand of ca. 7 400 tonnes. For the EV Scenario, the result is slightly more than 23 000 tonnes. This reflects the significantly higher electricity demand due to the steeper market ramp-up of electric vehicles.

It is useful to compare the cumulative figure of crystalline silicon demand according to the EV Scenario (around 23 000 tonnes) to the results of another source. In Falkenberg et al. 2019, the silicon demand for additional PV plants (power sector as a whole) between 2018 and 2030 was determined. The market growth there is based on the Scenario B (medium scenario) of the Grid Development Plan for Electricity 2030, as defined in the study [NEP 2019]. There, a cumulative silicon demand of 132 000 tonnes is expected between 2018 and 2030. This study comparison shows that the ambitious expansion of electric mobility certainly claims a noticeable share of the future silicon demand for PV systems. However, an even larger share is due to the necessary restructuring of the national

<sup>13</sup> Detailed information on this can be found in [JRC 2020].

electricity mix (reduction or phase-out of fossil and nuclear energy sources) as part of Germany’s energy transition.

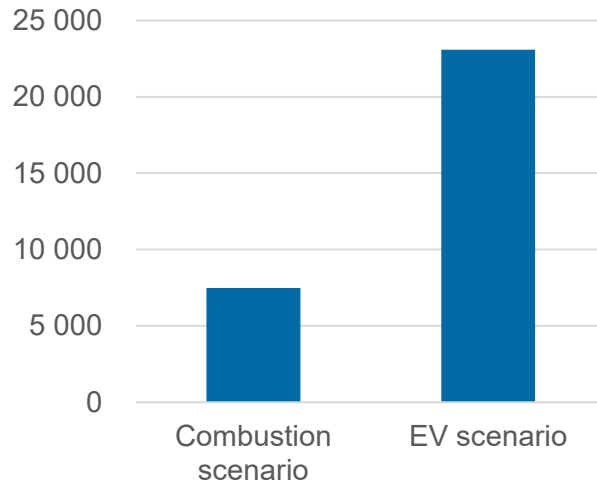

**Figure 25 Cumulative silicon (crystalline) demand for additional PV systems for EVs between 2020 and 2035 (national electricity mix)**

Regarding the demand for crystalline silicon for solar cells, it should be emphasised that in the past, driven by technological innovations, the specific demand in 2018 was reduced to a quarter of the specific demand in 2004. Experts expect a further reduction of the specific demand by at least another 20 % by 2035 [JRC 2018]. The specific use of silver for c-Si solar cells is also expected to more than halve by 2035.

### 3.5 Fossil energy carrier demand for charging EVs

Figure 26 and Figure 27 show the additional demand in the two scenarios for fossil energy carriers for electricity generation, which are required by the additional electricity demand for the BEVs and PHEVs.<sup>14</sup> As with the balancing of the raw material demand for wind power and solar plants, the development of Germany’s national electricity mix until 2035 is taken as a basis (see subsection 2.2). As expected, Figure 26 for the Combustion Scenario shows a moderate increase in the demand for fossil fuels. In total, there is an additional demand of almost 1.5 million tonnes of fossil energy carriers in 2035, of which lignite accounts for ca. 800 000 tonnes and the rest for natural gas. Following the German Federal Government’s decisions, hard coal shall no longer be used in electricity generation in 2035.

<sup>14</sup> To simplify matters, it was assumed for the scenarios, based on the goals of the energy transition, that there is no longer any relevant demand for materials and thus raw materials for new power plants based on fossil fuels.

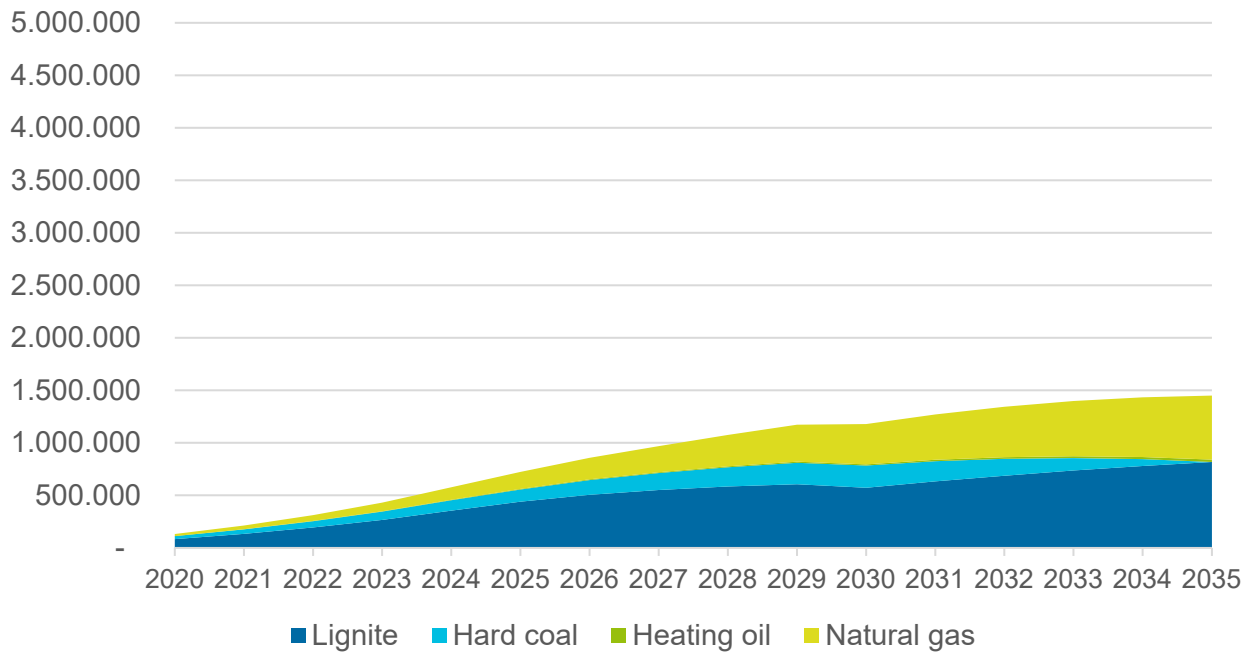

**Figure 26 Combustion Scenario: demand for fossil energy carriers for charging EVs, in tonnes**

In the EV Scenario in Figure 27, on the other hand, the ambitious growth of BEVs in the passenger vehicle market in Germany is also reflected by an increasing demand for additional fossil energy carriers for electricity generation. This demand rises to almost 4.5 million tonnes of fossil fuels by 2035, of which lignite accounts for ca. 2.5 million tonnes and natural gas<sup>15</sup> for almost 1.9 million tonnes.

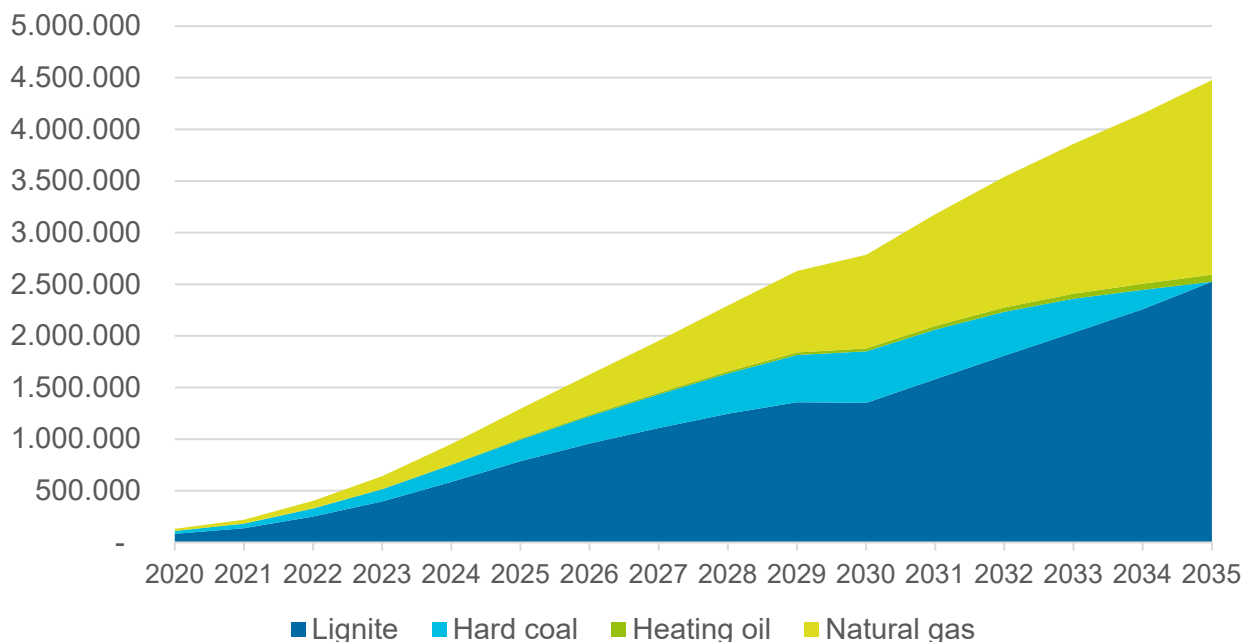

**Figure 27 EV Scenario: demand for fossil energy carriers for charging EVs, in tonnes**

<sup>15</sup> For natural gas, the unit tonne is rather unusual. It is used in this work for better comparability with the quantity requirements of other raw materials.

It is interesting to compare these additional 4.5 million tonnes of fossil fuels for the additional electricity demand with the amount of crude oil saved for diesel and petrol in 2035. In the EV Scenario, 28 million tonnes less of crude oil will be needed for the passenger car sector in Germany in 2035 compared to the baseline year 2020. In other words, the net saving of fossil resources is considerable. Finally, it should be remembered that lignite may no longer be used for power generation in Germany after 2038. Overall, the net balance in terms of fossil fuel savings could be even better under the two scenarios if the share of renewable energy sources in the national electricity mix were increased even faster and more significantly.

### 3.6 Excursus: Raw material demand for additional wind power and PV infrastructure with 100 % renewable energy used for EVs

In this subsection, the results of an excursus are presented. For this analysis, all scenario assumptions were left unchanged, apart from the approaches for the electricity mix for the additional electrical energy required to operate the additional electric vehicles (see subsection 3.4). Here, the entire additional electricity demand is now covered by additional wind power and PV plants. The aim is to show the effect on the additional demand for key raw materials that are relevant for these plants. It should be mentioned that in this case no additional demand for fossil energy sources would be generated for the additional electricity demand required for the market ramp-up of electric mobility. For example, for the EV Scenario in 2035, there would not be an additional demand for natural gas and lignite of almost 4.5 million tonnes for the additional electricity demand; the additional demand would instead be zero.<sup>16</sup>

Figure 28 shows the additional cumulative demand for rare earth elements (REE) for the Combustion and the EV Scenarios, which would be required for the additional wind power plants. For the EV Scenario, this results in a cumulative demand of a about 1 500 tonnes of REE between 2020 and 2035. A comparison with the results of the EV Scenario assuming the national electricity mix (around 900 tonnes REE) results in an additional demand for REE of around 600 tonnes. In other words, the REE demand here is higher by a factor of 1.66.

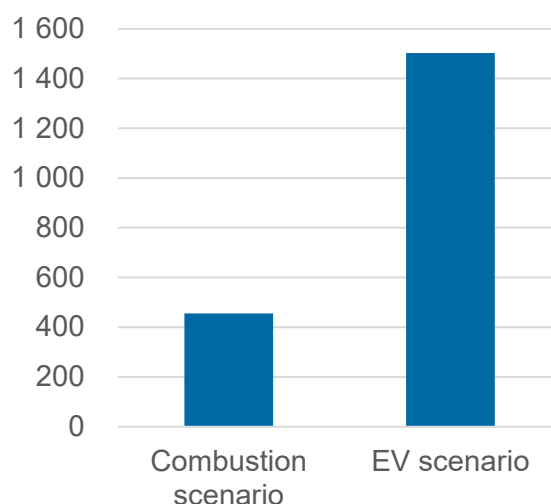

**Figure 28 Cumulative REE demand for additional wind turbines for EVs between 2020 and 2035 (100 % renewables), in tonnes**

<sup>16</sup> The cumulative fossil fuel savings between 2020 and 2035 are, of course, considerably higher.

Figure 29 and Figure 30 show the cumulative additional indium demand and the cumulative additional crystalline silicon demand for both scenarios. As with the REE for the wind turbines, it is assumed here for these two key elements for different PV cells that the additional electricity demand is covered exclusively by renewable energy sources. The EV Scenario now results in a cumulative demand for indium of around 13 tonnes and for crystalline silicon of almost 38 200 tonnes between 2020 and 2035. The difference to the results of the EV Scenario based on the national electricity mix (i.e. still with shares of fossil energy sources) is once again expressed in the factor 1.66.

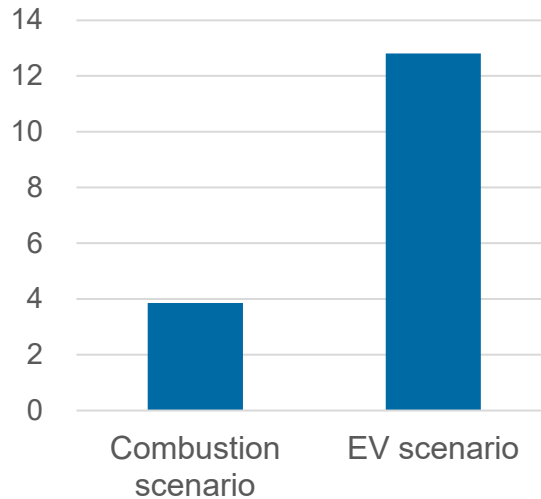

**Figure 29 Cumulative indium demand for additional PV systems for EVs between 2020 and 2035 (100 % renewables), in tonnes**

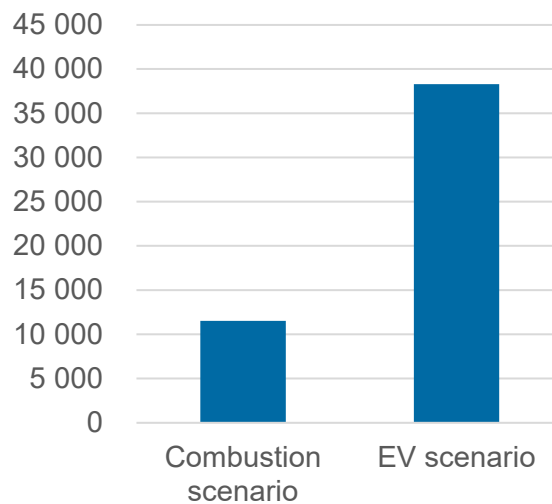

**Figure 30 Cumulative silicon (crystalline) demand for additional PV systems for EVs between 2020 and 2035 (100 % renewables), in tonnes**

It can be concluded from the results of this side analysis that the investment in additional raw materials for additional wind power and PV capacities would be justified, as conversely many million tonnes of fossil fuels are saved in electricity generation. It should also be considered here that the added capacities of wind power and PV plants will also continue to avoid the use of millions of tonnes of fossil fuels after 2035.

### 3.7 Excursus: Cumulative Raw Material Demand (CRD)

A quantitative comparison of the environmental and social impacts of the extraction of different raw materials is not an easy undertaking due to the different environmental effects. The pollution pattern of crude oil extraction in Nigeria, for example, is completely different from the extraction of lithium compounds from salt lakes in South America (see chapter 4). Notwithstanding this, a quantitative comparison of the two scenarios for the passenger car sector in Germany was carried out in this study with respect to total resource consumption by calculating the indicator Cumulative Raw Material Demand (CRD). CRD was defined in Giegrich et al. [2012] as follows:

CRD is defined as the sum of all raw materials – other than water and air – entering a system, expressed in units of weight.

The CRD therefore is calculated on the material level and is measured in tonnes. This means that the quantity of petrol and diesel and the metals (e.g. copper) and other materials (e.g. graphite) required for vehicle components and energy supply are included in the CRD quantifications of the two scenarios. For most materials, CRD factors from Giegrich et al. [2012] were used. Data gaps were filled by CRD factors from Steger et al. [2019]. In the case of metals, the CRD is highly dominated by the ore grades; accordingly, the factors for metals are significantly higher than for fossil fuels (e.g. typical commercial copper ore grades range at around 1 % copper).

The advantage of an indicator such as the CRD is its quantifiability with the simple unit of tonnes. The disadvantage is that it cannot be used to represent the different and complex environmental impacts of extracting different raw materials. CRD results are therefore to be understood as giving orientation, but they cannot provide conclusive assessments.

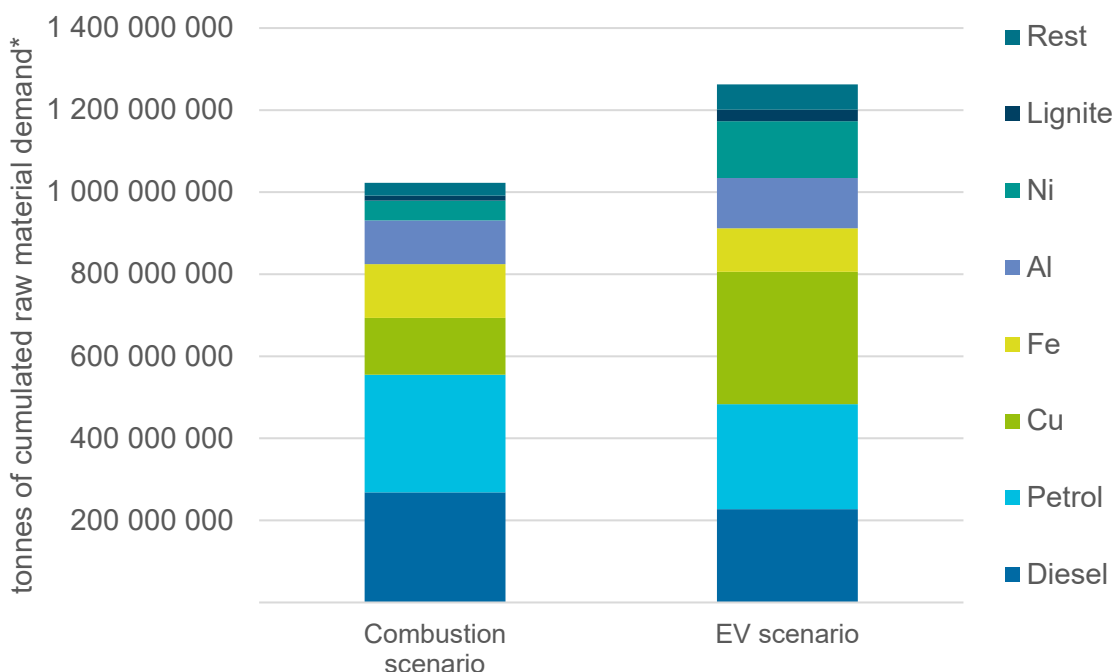

*\*The amount does not represent the net demand of each material only. E.g. when looking at copper, the metal plus waste rock plus fuels needed for mining etc. are all included.*

**Figure 31 Cumulative Raw Material Demand (CRD) 2020-2035 (cumulated), in tonnes**



While in the previous chapters metal demand volumes were calculated, the CRD contains all materials that were needed to produce a given commodity. Therefore, the CRD for copper represents all masses required to produce the metal. Accordingly, the calculated tonnage contains the metal itself, gangue material, fossil fuel needed for mining and processing and transport, chemical reagents for processing, energy carriers for smelting, etc.<sup>17</sup>. It must be highlighted that the results represent the CRD without recycling for all materials.

Figure 31 shows the cumulative result for both scenarios during the scenario period (2020 to 2035) without considering the potential for recycling. Overall, the Combustion Scenario, with a total CRD of 1.02 billion tonnes despite the partially low ore grades for EV metals, performs only slightly better than the EV Scenario with 1.26 billion tonnes.

The results are clearer when the entire CRD is broken down into the materials with the main contributions. In the EV Scenario, the contributions of petrol and diesel are significantly lower than in the Combustion Scenario. The significantly higher demand for metals such as copper, but also nickel and aluminium in the EV Scenario, however, due to low ore grades overcompensate the savings in petrol and diesel due to the stronger market ramp-up of electric mobility in terms of the CRD indicator. It must be considered that the CRD factors for metals such as copper (CRD = 128.1 tonnes for 1 tonne of primary copper) are significantly higher than, for example, for petrol (CRD = 1.173 tonnes for 1 tonne of petrol). Metals, on the other hand, are not destructively used in the vehicles. While fossil fuels are burned and dissipated, metals are still available for recycling and further use at the end of the vehicle life. In order to interpret this result, it is therefore important to emphasise that for the CRD data for metals, only data for primary raw materials were included in the calculation, while potential shares of secondary raw materials from recycling are not considered. Therefore, the results regarding metals represent the worst possible CRD. In real world scenarios, recycling plays a major role for the metals most prominently displayed in the CRD: the recycled content<sup>18</sup> for copper ranges between 20 % and 37 %, for aluminium between 34 % and 36 %, for nickel between 29 % and 41 % and for steel between 28 % and 52 % [UNEP 2011 A].

Figure 32 below thus differs from the results of Figure 31 by dividing materials that can be recycled and materials that are destructively used. For instance, fossil fuels like petrol, diesel or lignite are lost once they have been used to fuel an engine or a power plant. Metals on the other hand can remain in use in a circular economy. In the Combustion Scenario, more material is actually lost for good, while the impact of materials that can be recycled is lower. In the EV Scenario, the opposite is true; smaller volumes of non-recyclable materials like diesel are needed compared to the Combustion Scenario, but more recyclable metals are needed to fuel the EV transition.

---

<sup>17</sup> This is a very simplified explanation to better illustrate the meaning of the CRD and facilitate the interpretation of the results

<sup>18</sup> Recycled content represents the scrap content at the finished product level (e.g., scrap content in a car, as average over all materials) [UNEP 2011 A]

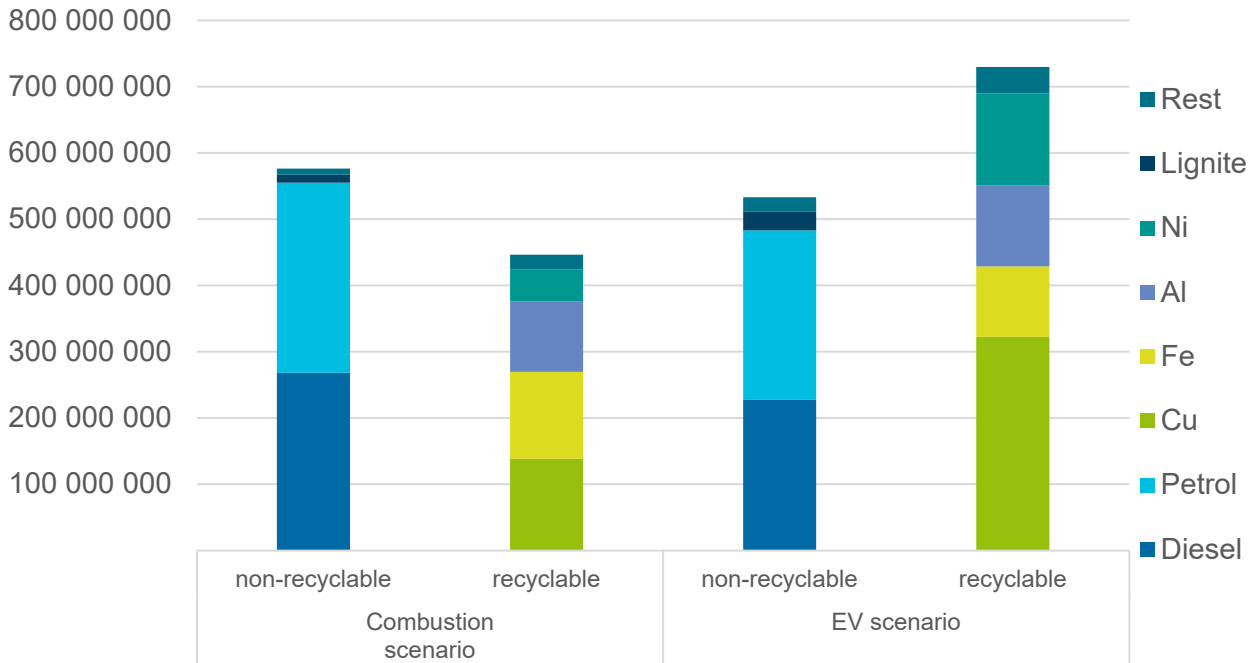

Note: In the EV scenario the non-recyclable part of material demand will be drastically reduced from 2035 onwards since the ICE stock is getting gradually smaller and is replaced by EVs

**Figure 32 Cumulative Raw Material Demand (CRD) by recyclability, 2020-2035 (cumulated), in tonnes**

The exact analysis of the results of the EV Scenario leads to further findings. Since all newly registered passenger vehicles in Germany will be BEVs from 2035 onwards, it can be assumed that the maximum raw material consumption will be reached around 2035. For example, the share of petrol and diesel in the CRD will go from 17.8 million tonnes to zero in the medium term after 2035. Other fossil energy sources in the national electricity mix, such as lignite, will also be phased out by 2038 at the latest. Increasing recycling shares for metal components will also significantly reduce the CRD. The EU Commission's proposal on battery regulation [EC 2020], published in December 2020, provides ambitious, metal-specific recycling quotas for key metals from lithium-ion batteries such as copper, nickel, cobalt and lithium from 2025, which are to be increased even further from 2030. In addition, minimum quotas for recycled content in LIBs are set for cobalt, nickel, and lithium from 2030, which are to be even higher from 2035. In scenarios with a long-term timeframe until 2050, a share of secondary metals of 40 % each for copper, nickel, lithium, and cobalt is considered for lithium-ion batteries [Buchert et al. 2017].

Finally, the following Figure 33 once again shows the demand quantities for diesel and petrol and the four metals steel, copper, nickel, and aluminium for the two scenarios. In terms of pure material quantities, fuels dominate very much over metals in the initial year. In the EV Scenario, massive declines can already be seen by 2035. If new passenger vehicles are fully electrified from 2035 onwards, this fuel demand and the associated crude oil demand will approach zero. As detailed in Section 4, the environmental impacts of extracting different raw materials show different patterns. Using an indicator such as CRD is one way of gaining an overall view, but it cannot in any case adequately cover all aspects of resource extraction.

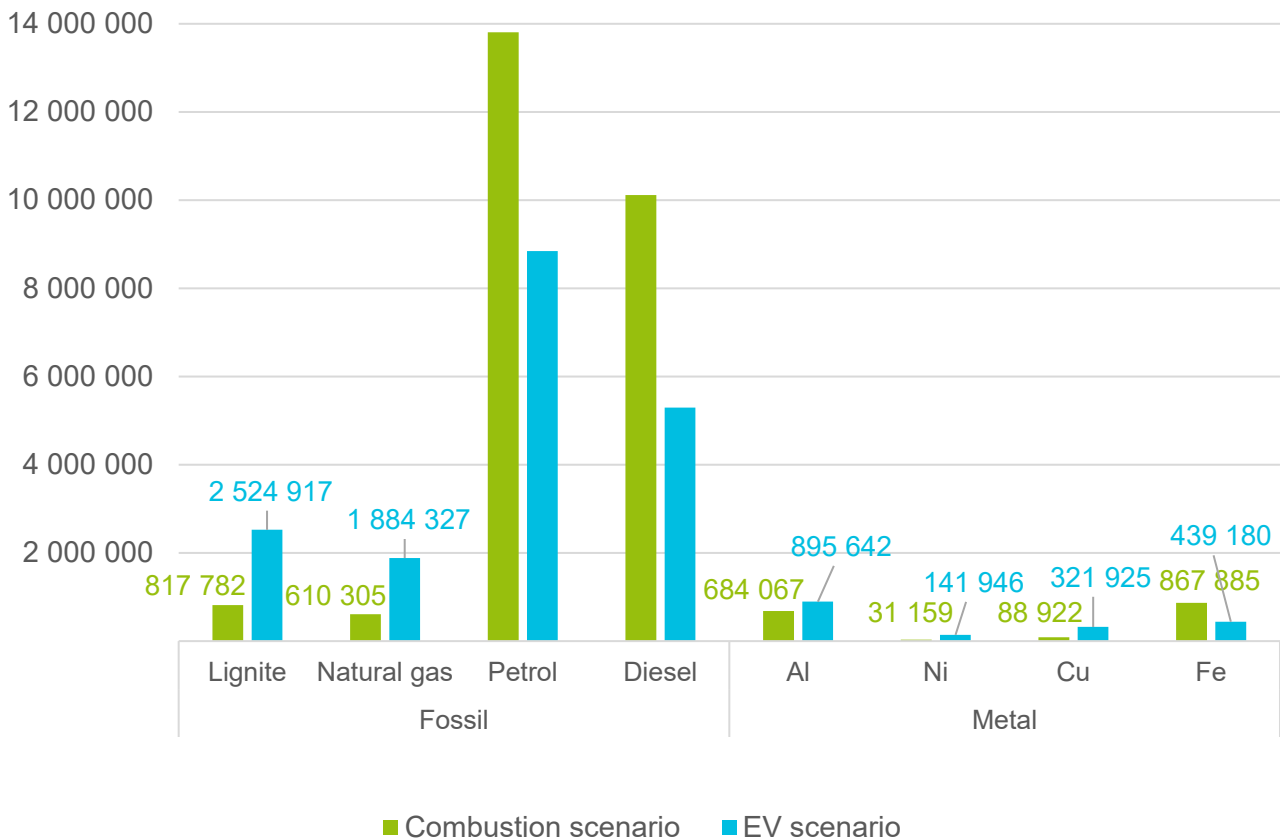

**Figure 33 Demand for fossil fuels and selected metals in 2035 under the two scenarios, in tonnes**

#### 4 Identification of ecological and social “hot spots” of raw material extraction

This chapter builds on the quantification of the possible raw material requirements based on relevant materials and energy sources for the development of the passenger car market in Germany up to 2035 that was performed in section 3. Since the core of this study is to work out which relevant social and environmental impacts are associated with the extraction of important resources for different passenger vehicle powertrains, a prioritisation and selection of the most important raw materials for this area is necessary. It must be emphasised that the list only includes raw materials that are specific to one or more powertrain. Therefore, steel or rubber<sup>19</sup>, for example, are not listed and treated as they are not specific.

**Table 3 Prioritisation of the quantified raw materials for further investigation**

Powertrains affected	Quantified raw materials	Relevance in the German passenger vehicle sector to total raw material demand (2020-2035)
ICE, HEV, PHEV	Crude oil	high
	Platinum group metals	high

<sup>19</sup> In the case of an overall view of the passenger car system, materials such as steel, rubber, but also aluminium, zinc, plastics, etc. would also be in focus, as the passenger car sector represents a large demand area here.

Powertrains affected	Quantified raw materials	Relevance in the German passenger vehicle sector to total raw material demand (2020-2035)
	Rhenium	low to medium
	Molybdenum	low to medium
ICE, HEV, PHEV, BEV	Cobalt	high
	Rare earth elements	high
HEV, PHEV, BEV	Lithium	high
	Graphite	high
	Nickel	high
	Copper	medium
PHEV, BEV	Lignite	low to medium
	Hard coal	low
	Natural gas	low to medium
	Indium	low to medium
	Silicon	low to medium





Table 3 above ranks the raw materials that show specific importance for one or more of the four drive types ICE, HEV, PHEV and BEV. The assessments are based on the results from section 3 as well as findings already known from specialist literature. For the detailed analysis of the social and environmental impacts of raw material extraction, only raw materials that are of high or paramount importance in the context of the project focus are used. For this reason, the extraction of these raw materials is examined in more detail in the following subsections: crude oil, platinum group metals (PGM), lithium, graphite, cobalt, nickel, and rare earths elements (REE).

The discussion of social and environmental hot spots in the following sub-chapters concludes with a general overall assessment for each commodity studied (either for global mix or selected producing countries). For this purpose, the evaluations of the environmental and social impacts of raw material extraction are given equal weight in the overall assessment. The assessments are made per commodity. The overall assessment is made with a five-level ranking. The following Table 4 explains the ranking criteria in more detail. The disclaimer below applies to all these ratings:

Disclaimer: an assessment is always dependant on the individual situation on the ground at any site. The evaluation presented here is based on a generalized summary of known common issues for a given raw material. No conclusion regarding specific sites can be drawn from this assessment.

**Table 4 Ranking scheme for overall assessment of raw materials**

Overall assessment of raw material extraction with regard to negative environmental and social impacts	Colour code	Classification criteria (country-specific or global mix)
low	●	Raw material extraction is <b>predominantly</b> carried out under <b>high standards</b> to avoid negative environmental and social impacts. The standards set by the authorities in the producing countries are <b>high</b> and compliance is <b>largely</b> monitored.

Overall assessment of raw material extraction with regard to negative environmental and social impacts	Colour code	Classification criteria (country-specific or global mix)
low/medium		Raw material extraction is <b>often</b> carried out under <b>high standards</b> to avoid negative environmental and social impacts. The standards set by the authorities in the producing countries are <b>quite high</b> and compliance is <b>usually</b> monitored.
medium		Raw material extraction is <b>only partly</b> carried out under <b>high standards</b> to avoid negative environmental and social impacts. The standards set by the authorities in the producing countries are <b>only partially high</b> and compliance with them is <b>only partially</b> monitored.
medium/high		Raw material extraction is <b>often</b> carried out under <b>low standards</b> to avoid negative environmental and social impacts. The standards set by the authorities in the producing countries are <b>usually low</b> and there is <b>little</b> monitoring of compliance or production methods known to cause environmental harm are used.
high		The extraction of raw materials is <b>predominantly</b> carried out under <b>low standards</b> to avoid negative environmental and social impacts. The standards set by the authorities in the producing countries are <b>very low</b> and compliance is <b>hardly</b> monitored, or production methods known to cause <b>severe</b> environmental harm are used.

The evaluation of raw material extraction is initially carried out separately according to environmental and social criteria. Subsequently, the evaluation is combined into an overall assessment. In borderline cases, as shown here in a fictitious example, the overall classification is made in the sense of a conservative approach in favour of the less favourable classification.

#### Raw Material X

Environmental:  Social:  Overall: 

It should be noted at this point that even a classification of 'low' does not mean that there are no negative environmental and/or social impacts associated with the extraction of raw materials. Mining activities or the extraction of crude oil from different deposits cannot take place with zero environmental impact. In terms of social impacts, for example, high labour and social standards of employees on the one hand can collide with divergent interests and claims of indigenous people on the other. Regardless, resource extraction can take place under very different social and environmental impacts. This will be explained in more detail in the next subsections for the priority raw materials.

## 4.1 Key raw materials for ICEs

### 4.1.1 Crude oil

Crude oil is essential to produce diesel and gasoline. The oil reserves are spread around the world in different forms (see Figure 34). Germany itself extracts only a very small portion of crude oil itself

and, therefore, relies on other countries to provide the crude oil it needs for refining into the necessary products. Only refining processes of crude oil for the German market are mainly done on German soil.

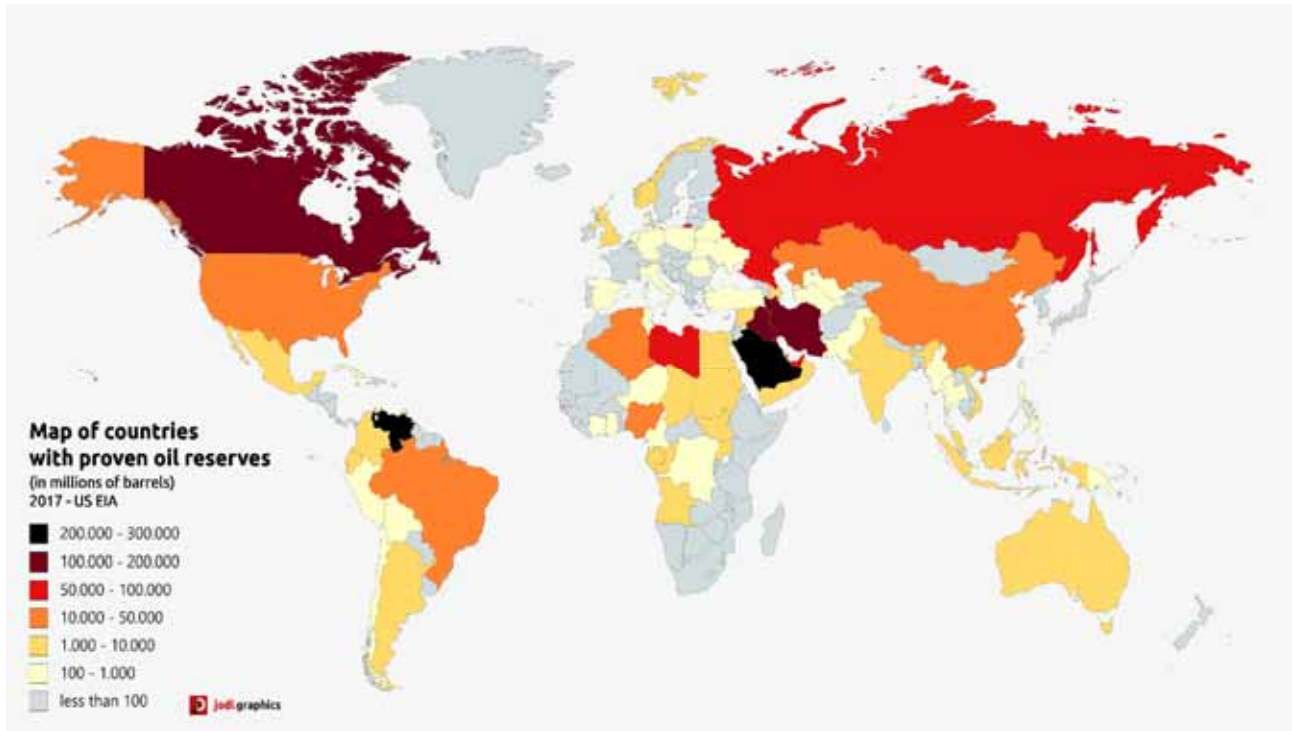

**Figure 34 Worldwide proven oil reserves in 2017<sup>20</sup>, in millions of barrels**

Many countries export crude oil to Germany, as can be seen in Figure 35. The main provider of crude oil for Germany’s refineries is Russia, which delivered 36.6 % of crude oil in 2018, followed by Norway (11.8 %), Libya (8.5 %), Great Britain (7.8 %), Nigeria (6.4 %) and the USA (4.6%). The USA is a special case, as its oil exports to Germany rose strongly over the last few years.

<sup>20</sup> “Map of countries with proven oil reserves according to U.S. EIA (start of 2017)” by Jo Di Graphics is licensed under CC BY-SA, [https://commons.wikimedia.org/wiki/File:Map-of-countries-by-proven-oil-reserves-\(in-millions-of-barrels\)---2017---US-EIA---Jo-Di-graphics.jpg](https://commons.wikimedia.org/wiki/File:Map-of-countries-by-proven-oil-reserves-(in-millions-of-barrels)---2017---US-EIA---Jo-Di-graphics.jpg) (08.12.2020)

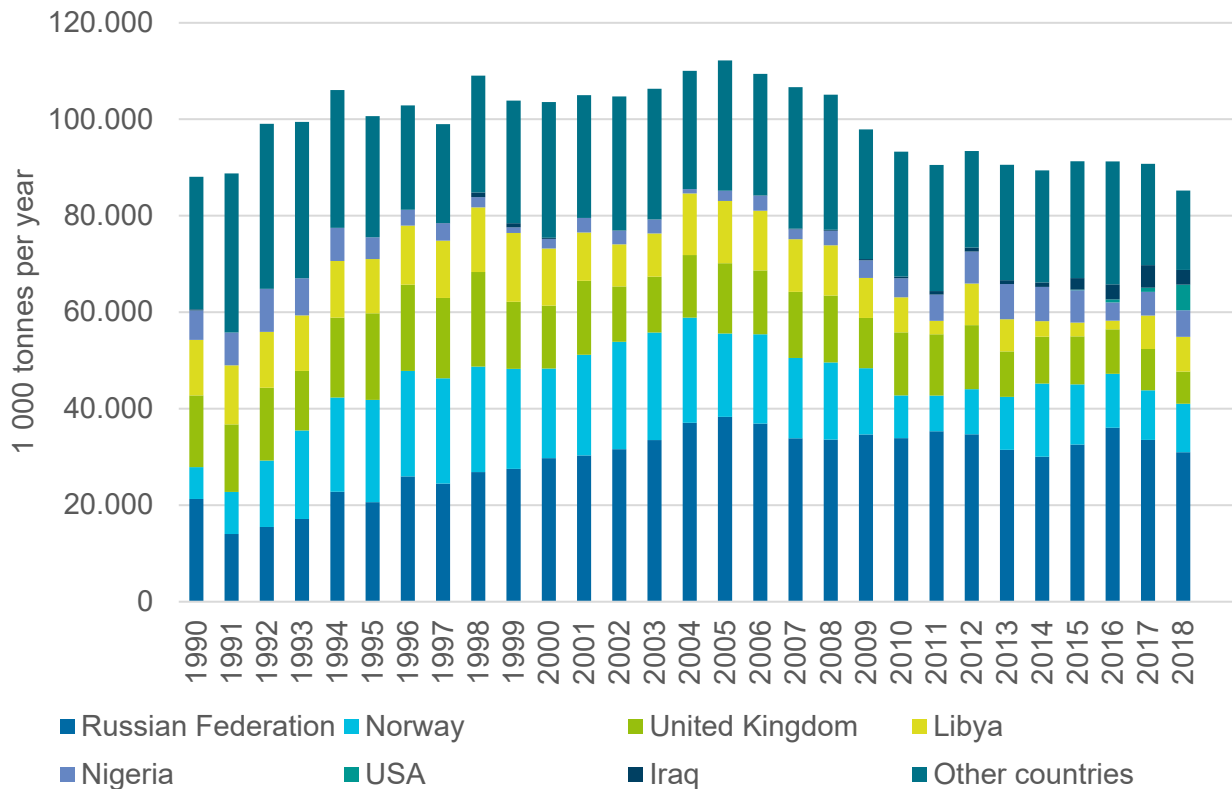

**Figure 35 Import of crude oil to Germany, 1990-2018, in thousand tonnes (data from [BMW 2019] and [BAFA 2020])**

The general trend of dwindling oil imports over the recent years from European countries like Norway and Great Britain is clearly visible. In Libya, for example, the conflicts starting in 2011 also led to a reduced amount of oil exported to Germany. However, although the Libyan conflicts are far from over, the amount of oil imported from this country has started to again rise sharply. This is also visible in Figure 36, depicting the oil production of countries providing the main supply of crude oil for Germany. These numbers include crude oil, shale oil, oil sands and condensates (both lease condensate and gas plant condensate) but exclude liquid fuels from other sources such as natural gas liquids, biomass and derivatives of coal and natural gas. The correlation of production and export to Germany is directly visible, although there are, nevertheless, fluctuations. For example, the amount of crude oil produced in Russia has risen constantly over the last years, while the exports to Germany vary. Other countries are satisfying the oil demand instead (e.g. Norway in 2014).

In general, crude oil must be produced by drilling into the earth with an oil rig. The drill hole is then stabilized by a steel pipe. In conventional oil wells, the pressure of the oil is enough to force the crude oil to the surface. Therefore, the steel pipe is connected to a so called “Christmas tree” above the surface, a complicated array of valves necessary to control the flow and regulate the oil pressure.

However, these regular crude oil sources have been reduced over the last decades, especially in countries with a long history of oil extraction like the US. Today, many oil wells rely on additional techniques like hydraulic fracturing, also called fracking, where the well is stimulated by external pressure by injecting fluids into the well. This technique is more expensive and comes with certain risks and additional problems, further discussed in section 4.1.1.5.



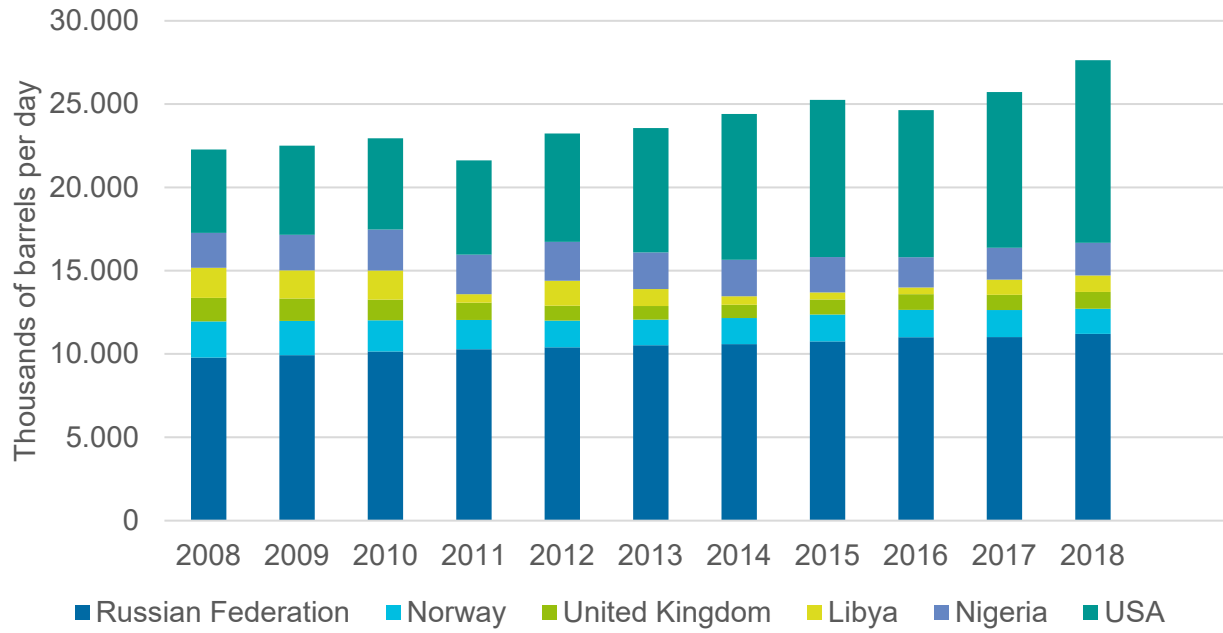

**Figure 36 Average daily crude oil production of the main crude oil suppliers for Germany, in thousand barrels, 2008-2018**



**Figure 37 Workers cleaning a beach after an oil spill<sup>21</sup>**

<sup>21</sup> “[Rena oil spill cleanup](https://www.flickr.com/photos/nzdefenceforce/6386602583/)” by New Zealand Defence Force from Wellington, New Zealand is licensed under CC-BY-2.0, <https://www.flickr.com/photos/nzdefenceforce/6386602583/> (08.12.2020)



Crude oil itself, as mentioned earlier, is a mixture of hydrocarbons with very negative effects on human health and the environment if there is direct contact (Figure 37). The negative effects of oil spills are well known. Many countries still suffer today from oil spills in the past, especially those at sea, since the spilled hydrocarbons can spread hundreds of kilometres, killing wildlife and requiring a lot of effort to reduce the immediate deadly consequences for the surrounding ecosystems. Indeed, not only is production problematic and risky, but also the whole crude oil value chain, including transport and the disposal or combustion in the end.

Another problem is the flaring (burning) or even venting of associated petroleum gas (APG, see Figure 38). APG occurs in a gaseous form immediately above the oil field to be sourced or in a bound form (dissolved) in crude oil. It can reach the surface during oil production, becomes gaseous again and evaporates due to the associated pressure drop. APG can emit at various points in oil production and processing (wells, storage tanks, etc.). It consists mainly of methane and other hydrocarbons. The components depend above all on the geographical location as well as the type and depth of the deposit and can vary greatly (average share of oil production from 1 % to 40 %). The share of associated gas is particularly high for light oil (e.g. over 30 % for shale oil), while heavy oil contains only small amounts of APG [Picard et al. 2006, Pieprzyk et al. 2016].



**Figure 38 Oil platform while flaring APG<sup>22</sup>**

APG can be used as fuel when the infrastructure to capture it is available. However, only about two thirds of APG is utilized; the rest is flared (i.e. burned) or vented. These are only rough estimates, as the amount of gas that is flared is very hard to detect; for venting, measurements are nearly impossible, as too many other sources of methane exist.

<sup>22</sup> Photo by unknown author licensed under CC0, (30.11.2020)

The result of flaring and venting of APG is not only the loss of valuable resources, emissions of toxic substances and soot and the disturbance of the surrounding nature by the light and smells but has also high impacts on climate change. During flaring, CO<sub>2</sub> is produced. Venting itself is even worse, as the climate change potential is 34 times higher than during combustion [Pieprzyk et al. 2016].

To discuss the social and ecological “hot spots” of crude oil production, this report focuses on five of the major oil providers, excluding Great Britain since its crude oil production is like Norway’s. The analysis of the crude oil production was structured to answer the following questions:

- Which type of crude oil production is dominant?
- What are the advantages and disadvantages of this type of production compared to others?
- Are there any specific characteristics for this country regarding oil production and transport?
- In addition to the ecological consequences, are there also social hotspots regarding oil production (e.g. military conflicts, working conditions, ecological effects on the population, expulsions)?

#### 4.1.1.1 Crude oil from Russia

In Russia, oil drilling predominately occurs on land with a continental subarctic climate, long and very cold winters and short but relatively warm summers. There are many reports about the pollution of rivers and ecosystems in the process of oil extraction and transportation [Feddern 2001, Kondratenko 2021]. Compared to other regions, Russian technical equipment is old and, therefore, many oil spills occur [Pirog 2007, Kondratenko 2021].

Over 7000 km<sup>2</sup> of land in the Western Siberia region have been contaminated with crude oil and estimates of the amount of crude oil spilled every year are between 4 and 20 million tonnes [Ponomarewa 2012]. Although Russian environmental restrictions have become stricter over time, there are still only low penalties for environmental pollution. It is reported to be often cheaper to leave the equipment like it is and pay the fines instead of renewing it [Pirog 2007, Kondratenko 2021].

There is a drive from the Russian government to obtain oil from the Arctic Sea, as the reserves seem to be quite large (estimated explored offshore oil reserves up to 5 billion tonnes) and resources on land are dwindling. Compared to Norway, with only 1 billion tonnes of proven reserves in the Arctic Sea, this is a huge amount [Kireeva 2019].

However, until now, there is only one Russian platform operating in the Arctic shelf, called the Prirazlomnoye, and with mild success. While Russia announced huge plans and tax cuts trying to increase its Arctic oil production in 2020, there are doubts that Russia will ever be able to increase crude oil production due to low oil prices, as producing oil in the Arctic is more expensive due to challenges with drilling in the sea floor, icebergs and storms. Furthermore, due to the challenging circumstances, it is unlikely that the necessary exploratory drillings are made. In general, Russia has had to cut back its current oil production by over 20 %. Sources state that these restraints will be reduced in the future but kept at least until April 2022 to stabilize the crude oil price [Khrennikova et al. 2020].

Furthermore, evidence suggests that the situation is not ready to improve. Due to climate change and the rising temperatures in Siberia, the permafrost ground is warming up as well. However, the structures built on top of the usually frozen ground rely on its (frozen) stability. When it is not frozen, the muddy ground cannot hold these structures any longer, as they are not built for this type of foundation, leading to collapses and accidents [S&P Global 2020 A]. One huge spill already occurred in 2020 due to the collapse of a structure below a fuel tank from the company Nornickel, releasing more than 21 000 tonnes of fuel into rivers and, ultimately, into the sea [Osborn et al. 2020].

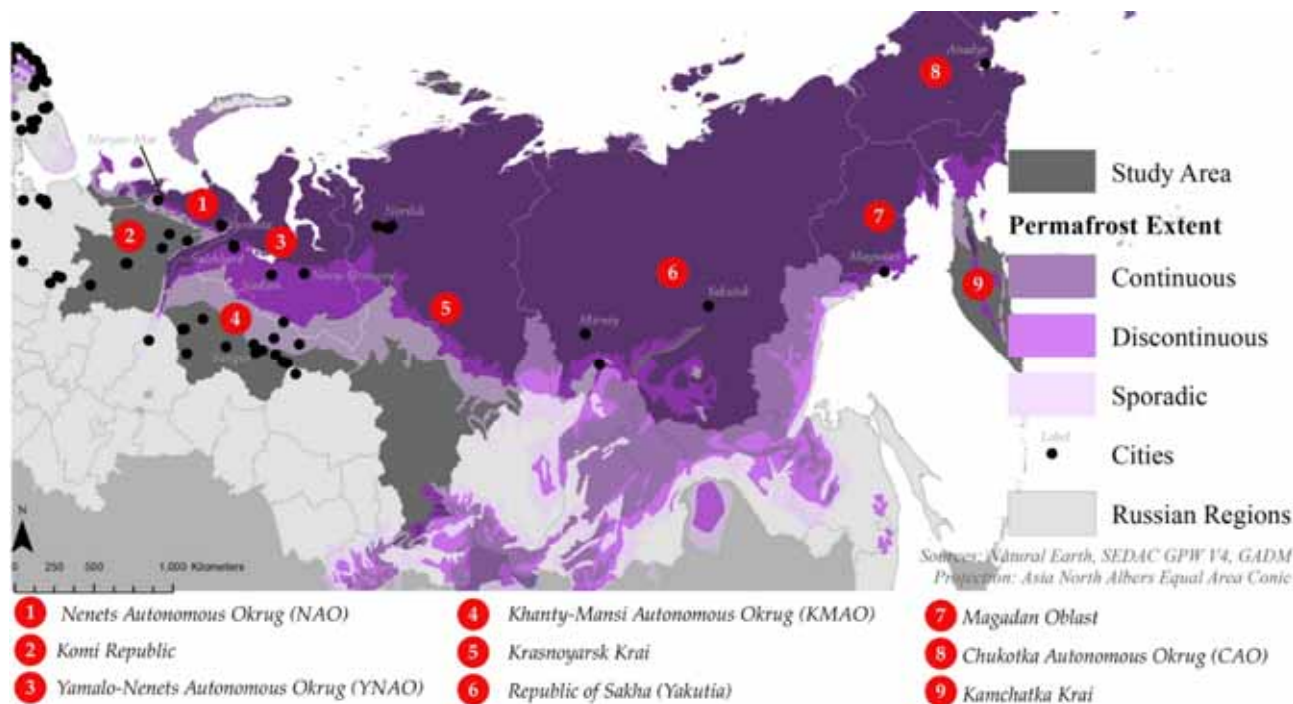

**Figure 39 Permafrost extent in Russia, taken from [Streletskiy et al. 2019]**

For the future, the risks are very high for infrastructure in the north of Russia, as can be seen in Figure 39. The temperature increase is expected to thaw the normally continuously frozen ground, where parts of the pipelines and oil fields lie. A similar problem with the thawing of permafrost earth impacting oil infrastructure can be seen in Alaska, USA.

On the other hand, Russia's state revenue seems to be highly dependent on its oil business. About half of its oil production is exported, most of it to Europe [BP 2019]. Also, local residents in some regions depend on the oil business to earn a living, like in the Khanty-Mansi Autonomous Okrug in West Siberia, where most of Russia's oil is produced [NEWSru 2012].

Nevertheless, also in West Siberia, there are reports of increasing protests against oil companies not caring for their faulty equipment. The Russian government is suppressing resistance of organisations like RAIPON, who defend the rights of the indigenous people and are critics of the involvement of drilling for crude oil in the arctic [Poussenkova 2018].

Another problem with environmental restrictions and the liability of the oil companies for their actions in Russia is corruption. Russia is 137th of 180 countries on the Corruption Perceptions Index of Transparency International.<sup>23</sup> At the same time, about 55 % of export revenue of Russia result from crude oil, gas and refinery products [Atradius 2020].

Flaring and venting of APG, described in section 4.1.1, is a major problem in Russia due to the lack of infrastructure and missing restrictions. Russia is reported to have the second highest flaring volume in the world, just behind Iraq [Pieprzyk et al. 2016].

**Crude oil from Russia, assessment:**

The impacts of crude oil production in Russia indicate that the biggest environmental concern is the enormous amount of oil spilled every year. It has already destroyed landscapes, while the resident population suffers. Regarding social issues, apart from corruption leading to

<sup>23</sup> <https://www.transparency.org/en/cpi> (30.11.2020)

less prosecution for environmental crimes, there are also protests against the environmental damage, but they are directed against the companies and their irresponsible behaviour, not the extraction of oil in general, as the people depend on it for their livelihoods. Nevertheless, these protest groups are suppressed by the government. Overall, the risk connected to crude oil production in Russia is estimated to be medium to high.

*Disclaimer: an assessment is always dependant on the individual situation on the ground at any site. The evaluation presented here is based on a generalized summary of known common issues for a given raw material. No conclusion regarding specific production sites can be drawn from this assessment.*

Environment: ● Social: ● Overall: ●

#### 4.1.1.2 Crude oil from Norway

In 2019, Norway was the 15<sup>th</sup> largest crude-oil producer in the world, which is extracted from platforms in the sea. Norway only consumes 12.5 % of the crude oil it produces itself; the rest is exported [BP 2019]. Of Norway’s total exports, 47 % are crude oil, gas or their products [Norwegian Petroleum Directorate 2020]. Some of the oil platforms are run by electricity from the mainland instead of using gas/diesel turbines, leading to a reduction of their climate impact. However, in Norway still about 25 % of CO<sub>2</sub> equivalents come from the oil and gas sector [Statistik sentralbyå 2020].



Figure 40 Oil Rigs outside Bergen, Norway<sup>24</sup>

<sup>24</sup> “Oil Rigs at Coast Center Base outside Bergen” by L.C. Nøttaasen licensed under CC BY-2.0, <https://www.flickr.com/photos/magnera/24172112301/> (08.12.2020)



At the beginning of 2020, a new Norwegian oil field (Johan Sverdrup) was opened up, containing 2.7 billion barrels of crude oil that could serve as an oil reserve up to the 2070s [Strittmatter 2020]. Although there is extensive exploration in the Barents (Arctic Sea), the oil wells often seem to be disappointing. Nonetheless, two fields are operational in the Norwegian part of the Arctic: the Snøhvit and the Goliat; and another one, the Johan Castberg field, is planned to begin operation in 2022. As it is very expensive to drill in the Arctic Sea, low oil prices lead to less new exploration [Holter 2020, Adomaitis 2020, Offshore Technology 2020].

The Norwegian safety regulations are high; therefore, the number of incidents (oil spills, accidents, etc.) are comparably low. Nevertheless, in 2007, 25 000 barrels (5 000 t) of crude oil were spilled in the Arctic Sea near Norway, only topped by an accident in 1977 (75 000 barrels) after a platform blowout [The Maritime Executive 2007]. Therefore, even under nearly perfect conditions, the risk of oil spills still exists and can impact the surrounding environment.

The politics around the crude oil industry in Norway are controversial. Norway itself is aiming to become a world environmental leader, transforming the automotive sector to electric mobility by strong tax cuts [Figenbaum et al. 2015] and producing 95 % of its electricity by hydro power [Statistik sentralbyrå 2020]. At the same time, its wealth is based on the oil and gas industry and it still gives away new exploration sites to drill for oil [Nilsen 2020]. This conflict is also exemplified by Norway's sovereign wealth fund. Norway has the world's biggest sovereign wealth fund, worth over \$1 trillion due to their oil, which today, however, exempts oil exploration from its investments [Solsvik 2020, Zadikian 2020]. Furthermore, the 'ice edge', the virtual boundary that determines how far north it is still possible to drill for oil, has moved slightly south, although the ice generally tends to recede. However, the boundary was placed around former oil wells and exploration sites to still allow for their further exploration and also to satisfy the oil industry and its investors. The number of inactive exploration sites is still very high, with little interest in expansion at present as falling oil prices also make Arctic oil rather uninteresting for companies [Berlund 2020].

#### **Crude oil from Norway, assessment:**

Overall, the situation for oil production in Norway is better than in other countries. Although oil spills still occur from time to time, which devastate the natural habitat surrounding the incident, governmental regulations have proven to be successful in decreasing the potential environmental risk and increasing the safety of the workers. Furthermore, revenues from oil benefit the whole country, leading to very high standard of living.

*Disclaimer: an assessment is always dependant on the individual situation on the ground at any site. The evaluation presented here is based on a generalized summary of known common issues for a given raw material. No conclusion regarding specific production sites can be drawn from this assessment.*

Environment: ● Social: ● Overall: ●

#### **4.1.1.3 Crude oil from Libya**

Libya, a country in Northern Africa on the Mediterranean Sea, and therefore directly opposite the European Union, produces up to 988 thousand barrels of crude oil a day, mostly from regular crude oil sources onshore [BP 2019]. The oil and gas revenues in 2019 alone were more than \$26 billion [OEC 2020], while Libya has the tenth largest proven oil reserves in the world (48.8 million barrels)

[BP 2019]. More than 90 % of Libyan exports come from the sale of oil or its products [OEC 2020], which makes it completely dependent on the oil market.

At the same time, since 2011, there have been two civil wars in Libya after the ouster of the Libyan leader Muammar Qadhafi, and the resulting civil war is still ongoing. There are several parties striving for power, mainly the House of Representatives (HoR), based in Tobruk, and the Government of National Accord, based in Tripoli, which are both again backed up by different countries. From 2011 to 2015, over 21 000 people were killed in the conflict [Daw et al. 2015], which has continued since then.

As sources suggest, all sides depend on the export of crude oil and the resulting revenues. Libya's only legal oil exporter is the state oil company NOC (National Oil Corporation), which operates in joint ventures with foreign oil companies [Johnson 2020].

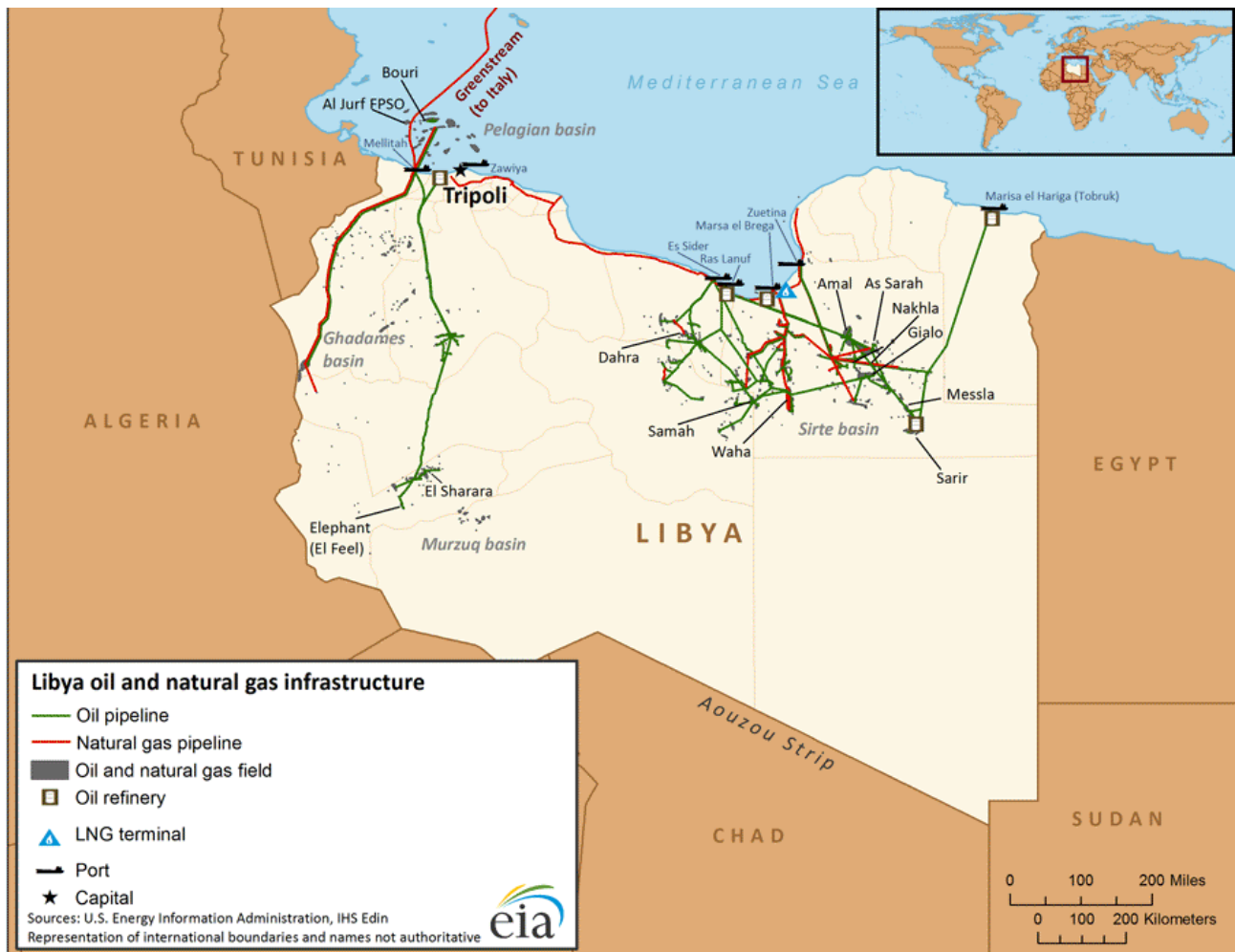

Figure 41 Oil and gas industry in Libya<sup>25</sup>

The Central Bank, stationed in Tripoli, pays all state salaries nationwide, including in the territory of the HoR, led by General Haftar in the east of the country, where most of the oil fields lie (see Figure 41). The NOC provides all fuel for the entire country, although Haftar's forces try to smuggle crude oil out of the country to earn directly from the revenues. Many militias and war leaders rely on wages paid by the central bank money and run their vehicles and planes on NOC fuel. Haftar and its

<sup>25</sup> US Energy Information Administration (EIA) (2015): Country Analysis Brief: Libya. [https://www.eia.gov/international/content/analysis/countries\\_long/Libya/libya.pdf](https://www.eia.gov/international/content/analysis/countries_long/Libya/libya.pdf) (20.01.2021)

associated militias control all major oil fields in the country and several oil ports, but not the largest oil refinery in Zawiya in western Libya (see Figure 41). The oil cycle brings the warring parties together: oil flows from Haftar's areas, money flows through the government [Johnson 2020].

Reports suggest that if this cycle in Libya were interrupted, both war leaders would have to capitulate immediately and Libya would sink into chaos. Yet if this cycle is maintained, the war continues [Johnson 2020].

Due to the crisis, oil exports from Libya fluctuate strongly. In the beginning of 2020, there was a blockade of oil exports and some oil fields, which decreased their crude oil production below 100 000 barrels a day until the blockage was lifted again in June 2020 [Aljazeera 2020 A, Xinhua 2020].

#### **Crude oil from Libya, assessment:**

As there is not much information about the environmental challenges of oil production in Libya, one has to assume that the usual problems related to oil spills occur, especially, as there is no functioning government in control over the whole country to uphold regulations. The main problem in this country is the social division, which has repeatedly led to civil war in recent years, while the oil revenues are funding the various sides.

*Disclaimer: an assessment is always dependant on the individual situation on the ground at any site. The evaluation presented here is based on a generalized summary of known common issues for a given raw material. No conclusion regarding specific production sites can be drawn from this assessment.*

Environment: ●      Social: ●      Overall: ●

#### **4.1.1.4 Crude oil from Nigeria**

The history of crude oil production in Nigeria indicates that it is a disaster in many regards. The major problems with oil production in Nigeria are related to the Niger Delta, one of the largest wetlands on earth and the largest river delta in Africa. It houses the largest mangrove forest on the continent, with over 7 000 km<sup>2</sup> and serves to feed the local population through agriculture, fish and drinking water. It has a very high population density of around 1 250 people per square kilometre [Kloff et al. 2005, Puschkarsky et al. 2014].



**Figure 42 Oil contamination in Ogoni land, Nigeria<sup>26</sup>**

The contamination of the Niger Delta resulting from oil spills is substantial and has been going on for over 50 years. In a report by the United Nations Environment Programme (UNEP), the profound disaster is extensively described [UNEP 2011 B]. In the Ogoni region in the Niger Delta, the pollution is so substantial that crops cannot grow since a continuous clay layer is missing to protect the groundwater from oil spills on the surface. In many cases, UNEP could observe residues of oil spills in the soil down to a depth of at least 5 m. This implies that cleaning the area would be very difficult to nearly impossible. In addition, in many cases, heavy contamination of drinking water was found (41 out of 142 sites had values higher than the official limit). Additionally, the danger of fires strongly increases with an oil spill, aggravating the situation even more. Fish reveal no signs of contamination, but they migrate to other areas which are very difficult for some fishermen to reach. Mangrove forests, which serve as breeding grounds for many types of fish, are being destroyed. Oil contamination has been found in water from 28 wells in 10 communities near affected sites. At seven wells, the samples contained hydrocarbons at least 1 000 times higher than the Nigerian drinking water standard of 3 µg L<sup>-1</sup>. Local communities are aware of the pollution and its dangers but indicate that, without any other alternatives, they would continue to use the contaminated water for drinking and their other daily needs [UNEP 2011 B].

The responsible oil companies have faced several court cases over the years, some of them continuing in 2020 [Ridderhof 2013, Austin 2019, Amnesty International 2020 A]. Since 2012, the oil production in the Ogoni region is conducted by the Nigerian Petroleum Development Company (NPDC)

<sup>26</sup> "Environmental degradation in Nigeria" by Ucheke is licensed under Environmental degradation in Nigeria, [https://commons.wikimedia.org/wiki/File:Environmental\\_degradation\\_in\\_Nigeria.jpeg](https://commons.wikimedia.org/wiki/File:Environmental_degradation_in_Nigeria.jpeg) (08.12.2020)



as part of the Nigerian National Petroleum Corporation (NNPC), which, however, cooperates with foreign oil companies [Shell 2018].

A huge programme (\$1 billion) was launched by the Nigerian government in 2018 to clean up the contaminated Ogoni region following the mentioned UNEP report [UNEP 2011 B, UNEP 2017]. However, reports suggest that the clean-up is going very slowly due to governmental procedures, lack of organization and corruption (Corruption Perceptions Index of Transparency International, 146th place of 180 countries<sup>27</sup>) [Shell 2018, Nwannekanm 2019, Amnesty International 2020 B]. Furthermore, the contamination seems to continue due to old pipelines and criminal activities [Puschkarsky et al. 2014, Shell 2018, UNEP 2011 B].

In the Nigerian oil industry, there are many accidents with fatalities, often related to illegal oil drilling or the tapping of oil pipelines [Slav 2018, Paraskova 2019]. Apart from accidents, there are also intentional blow-ups of facilities by militias [Babatunde 2020], connected to social uprisings of unemployed youths and organized rebels who fight for their right and wealth, leading to violence [Crisis Group 2006]. There are reports of groups actively destroying oil pipelines, attacking drilling sites and workers. Others report the use of illegal refineries to refine stolen oil to sell the products to the black market, leading again to additional environmental problems [Babatunde 2020].

Despite all the problems resulting from crude oil production, Nigeria is almost completely dependent on its oil. Oil is a main part of Nigeria's export revenue; oil, gas and distillation products provided up to 83.9 % of its export revenue in 2019. Furthermore, the largest part of non-oil exports are re-exports and therefore do not really add to the revenues of the country [Nairametrics 2020].

The biggest importer of Nigerian oil in 2019 was India, followed by Spain and The Netherlands, which in turn export much of the oil to other European countries [Adesoji 2019]. The Nigerian government, with its Local Content Act, aims to have participation of the indigenous work force, resources, and materials in any oil-drilling operation of at least 70 % [Osagie 2013]. Nevertheless, the poverty of the Nigerian people is rising again, with 40 % of Nigerians earning less than \$1 per day, not counting the state Borno, which is hit the worst by the Boko Haram armed uprising. Apart from a rich elite, the Nigerian government has thus far failed to spread the oil wealth equally [Aljazeera 2020 B, Egba 2020].

### **Crude oil from Nigeria, assessment:**

Oil extraction in Nigeria has led to disastrous pollution of the Niger Delta with massive consequences for the environment and the health of the regional population. The local population's lack of participation in the revenues from oil extraction leads to ongoing social tensions, leading to violence and attacks from various militias.

*Disclaimer: an assessment is always dependant on the individual situation on the ground at any site. The evaluation presented here is based on a generalized summary of known common issues for a given raw material. No conclusion regarding specific production sites can be drawn from this assessment.*

Environment: ● Social: ● Overall: ●

---

<sup>27</sup> <https://www.transparency.org/en/cpi> (26.11.2020)

#### 4.1.1.5 Crude oil from the USA

The USA has a long history of crude oil production. Today, the USA extracts oil from conventional oil sources found on land and in shallow water, in addition to deep-sea oil wells in the Gulf of Mexico and tight and shale oil produced by fracking. Starting in the beginning of the 20<sup>th</sup> century, oil production in the US had its first peak in 1970 (“peak oil” in Figure 43). After this point, conventional oil production has been declining steadily. However, in the 21<sup>st</sup> century, the production of tight oil by fracking (see chapter 4.1.1) rose strongly due to new technology combined with other technical advances to stimulate formerly decreased oil production in certain wells (directional drilling, multi-well pads and micro-seismic monitoring during fracturing). High oil prices also played a role, especially in the beginning. Daily crude oil production even exceeded that of 1970, leading to a second peak, however, with production falling even faster afterwards. The reasons for this are manifold and are largely due to low oil prices and the flexibility of the new fracking technology.

#### U.S. Crude Oil and Condensate Production and Forecast

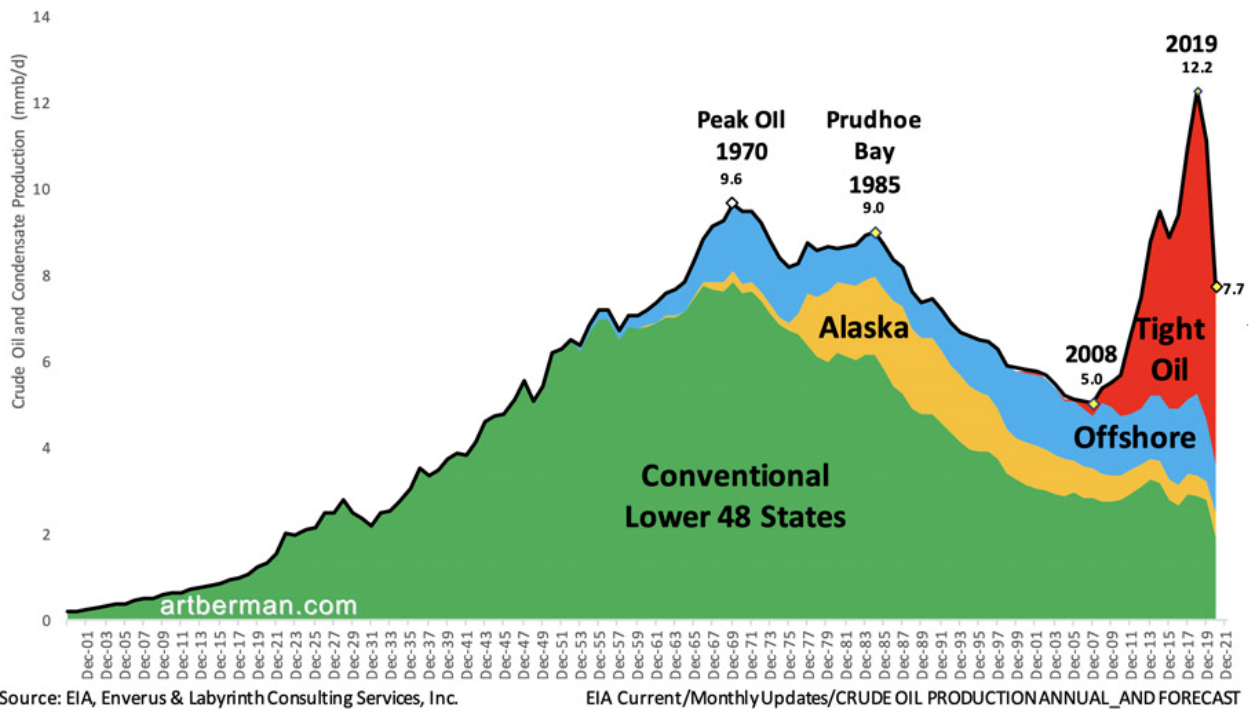

Figure 43 Crude oil production in the USA from 1900 until 2020<sup>28</sup>

The fracking industry uses liquids with high pressures (fracking fluids, mostly water with quartz sand and additives)<sup>29</sup> to fracture the oil and gas containing rock formation as depicted in Figure 44.

<sup>28</sup> “U.S. Crude Oil and Condensate Production and Forecast” by Art Berman (based on EIA and Labyrinth Consulting Services, Inc.) is licensed under Unknown, <https://www.energyandourfuture.org/2020/11/02/no-matter-who-wins/> (27.11.2020)

<sup>29</sup> <https://de.statista.com/statistik/daten/studie/601932/umfrage/zusammensetzung-des-frack-fluids/> (27.11.2020)

There are several problems related to fracking which lead to it being a highly controversial topic. Several European countries have the possibility of exploiting gas and oil and have decided differently whether to start exploring these potential deposits [Cremonese et al. 2015].

Firstly, fracking has a large water consumption. In North Dakota, which has a high share of the fracking industry in the US, over 40 % of annual water consumption (including all households and industry branches) from 2007 to 2017 could be attributed to oil and gas production [USGS 2020 B]. Furthermore, there is always the danger of methane infiltration in aquifers and aquifer contamination by the used, often toxic chemicals. Additionally, as depicted in Figure 44, the pressurized liquids not only fracture the surrounding rock bed but can also induce local seismicity [Cremonese et al. 2015].

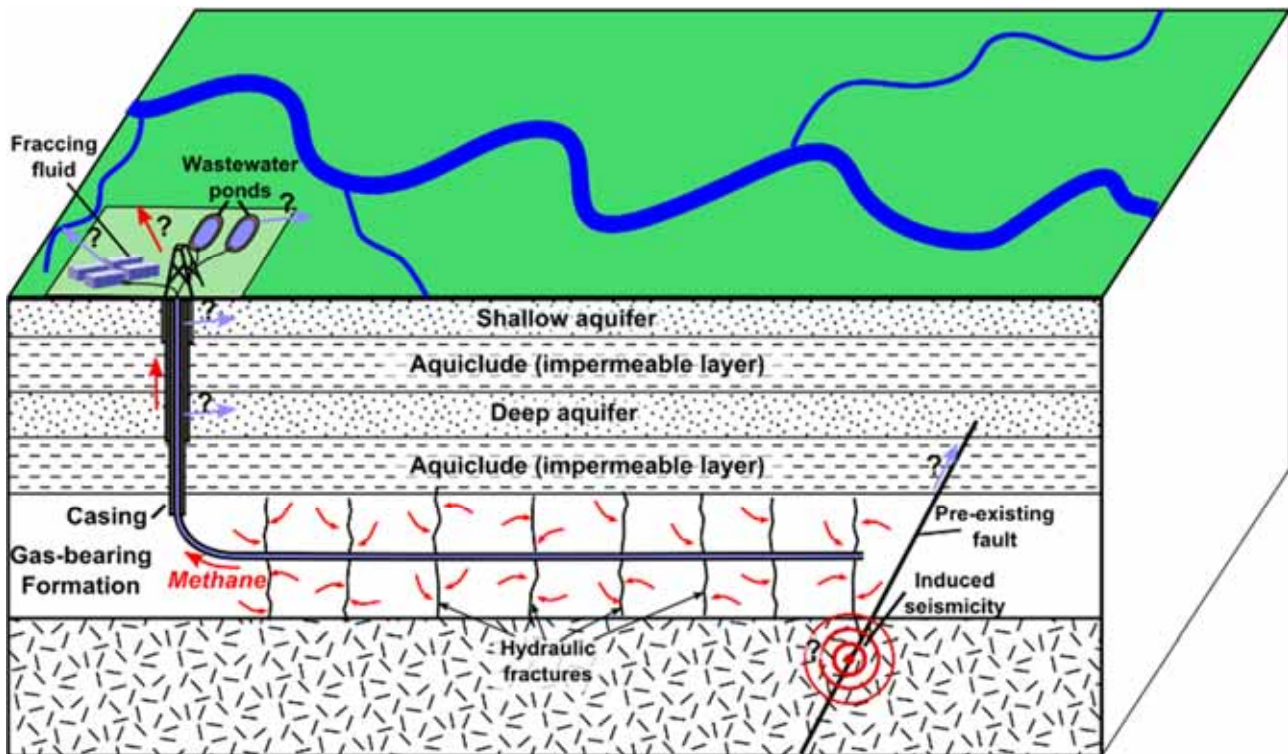

**Figure 44 Schematic depiction of hydraulic fracturing for shale gas, showing main possible environmental effects<sup>30</sup>**

Compared to conventional oil production, fracking has a larger surface footprint because more wells have to be drilled as they run out faster. This is also the reason for the rapid decline in oil production, since once not enough additional wells are drilled, the existing ones quickly dry up. In addition, there is a lack of infrastructure to cope with associated petroleum gas (APG). The built up of infrastructure to use APG, e.g. through liquefaction, is often not economically viable. This leads to a strong correlation between the number of fracking sites and the amount of vented or flared APG, as many fracking companies do not bother with building up the necessary infrastructure to use the APG as an energy source but just release or burn it. It is reported that the residents surrounding the new fracking sites, in part native Americans, are glad about the possible employment with the oil companies but do suffer from tight oil and gas production due to pipeline leaks, oil spills, methane infiltration in aquifers and flaring [Bauer 2020].

In general, high investments are necessary for the hydraulic fracturing process, leading to higher costs per barrel of oil. Therefore, without high oil prices, this process does not pay off [Kromarek et

<sup>30</sup> "Schematic depiction of hydraulic fracturing for shale gas, showing main possible environmental effects" by Mikenorton is licensed under CC BY-SA 3.0, (<https://commons.wikimedia.org/wiki/File:HydroFrac.png>) (21.01.2021)

al. 2020]. Reports show that the number of rigs for tight oil and gas production was declining even before the Corona pandemic. As the well capacity decreases strongly over time, this leads to declining tight oil production in the US. In 2020, the Corona crisis led to declining investments for new rigs and reinforces this trend [Berman 2020].

In general, tight oil is very light and, in part, exported, as US refineries are not perfectly fitted for such light oils [Rost 2014]. There was a ban on crude oil export, which was lifted in 2015, making this possible [BBC 2015]. In contrast, European oil refineries are not as prepared for heavy oil compared to the USA. Therefore, they welcome the light oil. The Trump administration supported the tight oil boom by restricting environmental legislation, but the increase in the number of drilling operations began even before autumn 2016 and can rather be explained by the higher oil prices or its forecast [Kornfeind 2020, Thompson 2018].

Apart from the steady decline of conventional oil production and the crude oil produced by fracking, the US also produces oil offshore, e.g. around the coast of Alaska and especially in the Gulf of Mexico. Drilling offshore has several disadvantages, especially the increased impact of oil spills compared to on land. Furthermore, it is also more dangerous, as handling the drilling in the deep sea is not as easy and problems cannot be fixed as fast, best demonstrated by the disaster that happened on the Deepwater Horizon rig, a platform in the Gulf of Mexico, in 2010 (see next picture). The incident killed eleven workers and millions of barrels of oil were reported to have spilled into the sea as the leak on the sea floor could not be immediately sealed properly [Krauss et al. 2010].



**Figure 45 Burning oil platform Deepwater Horizon<sup>31</sup>**

<sup>31</sup> Picture free of copyright, <https://pxhere.com/en/photo/1235822> (21.12.2020)



Furthermore, in the Gulf of Mexico, there are usually twelve named storms per year, often leading to the evacuation of the offshore platforms [S&P Global 2020 B, Reuters 2020 A, OE Digital 2020]. This is another problem, which is reported to be aggravated by climate change as well, as with higher temperatures the number and strength of these storms rises. Florida, on the other hand, rejects drilling sites off its coast because of fear of oil spills and the impact on tourism [The Hill 2020].

Low oil prices make it difficult for oil companies to continue drilling for oil offshore, as it is more expensive [Slav 2020]. In the first half of 2020, while other countries were rationing their oil production to stabilize the prices, the US would not take part [The Texas Tribune 2020].

In Alaska, the amount of oil produced is declining rapidly. Offshore drilling in Alaska is often conducted by creating an artificial drilling island next to the coast [AP 2018, Offshore Energy 2018, Offshore Energy 2019], but there is also still conventional oil production taking place on land in Alaska. Part of the area in Alaska suspected of containing crude oil is in the Arctic National Wildlife Refuge, home to many endangered wildlife species. Until 2020, environmental and political opposition avoided the exploration of this region. The Trump administration changed this, opening up the region for exploratory drillings, and therefore increasing the risk of extinction of some of the animal species, especially migratory birds [Offshore Technology 2019, Oilfield Technology 2020]. The newly elected Biden administration has issued a moratorium on the drillings; however, this is not yet permanent [DeMarban 2021].



**Figure 46 Oiled bird after an oil spill<sup>32</sup>**

Apart from the Deepwater Horizon incident, there have been other huge oil incidents in the USA, like the Exxon Valdez oil spill, when an oil tanker ran into a reef in Alaska in 1989. The amount of spilled oil was smaller than other oil spills (257 000 barrels or 35 000 tonnes), however, with catastrophic results for the environment, as it happened in a remote area with a high density of animals. Several hundred thousand of animals (seabirds, seals, eagles, whales and fish) were reported to die from

<sup>32</sup> "Oiled Bird - Black Sea Oil Spill" by Igor Golubenkov licensed under CC BY 2.0, <https://www.flickr.com/photos/19378856@N04/2037098785> (21.12.2020)

the consequences and more still suffer [EVOSTC 2020]. Several smaller oil spill incidents have been registered since then over the last years, including one in the Northern Alaska region at Prudhoe Bay field with 6 400 barrels of crude oil spilled [BBC 2006, Reuters 2020 B].

**Crude oil from the USA, assessment:**

There are many types of oil production in the US, which in turn have different impacts on the environment. Fracking especially has negative effects, even if high risk-assessment takes place before drilling. Oil spills in the USA are common and have had devastating effects, but there are governmental regulations in place to restrict oil companies to avoid such events in the future or to at least limit their effects.

*Disclaimer: an assessment is always dependant on the individual situation on the ground at any site. The evaluation presented here is based on a generalized summary of known common issues for a given raw material. No conclusion regarding specific production sites can be drawn from this assessment.*

Environment: ● Social: ● Overall: ●

**4.1.2 Platinum group metals**

The group of platinum group metals (PGMs) comprises the six precious metals platinum (Pt), palladium (Pd), rhodium (Rh), ruthenium (Ru), iridium (Ir) and osmium (Os). Since the different PGMs occur together in varying proportions in most natural deposits, they are extracted in different proportions from the respective deposits. This section focuses on the primary extraction of the two most important PGMs in terms of production quantities, Pt and Pd, which are also the most relevant in the field of automotive catalysts applications. According to the US Geological Survey [USGS 2021 A], global mine production in 2019 for platinum was 186 tonnes. As can be seen from Figure 47, South Africa has an overwhelming share of world mine production, with 72 % in 2019. Russia is in second place with 13 % in the same year [USGS 2021 A].

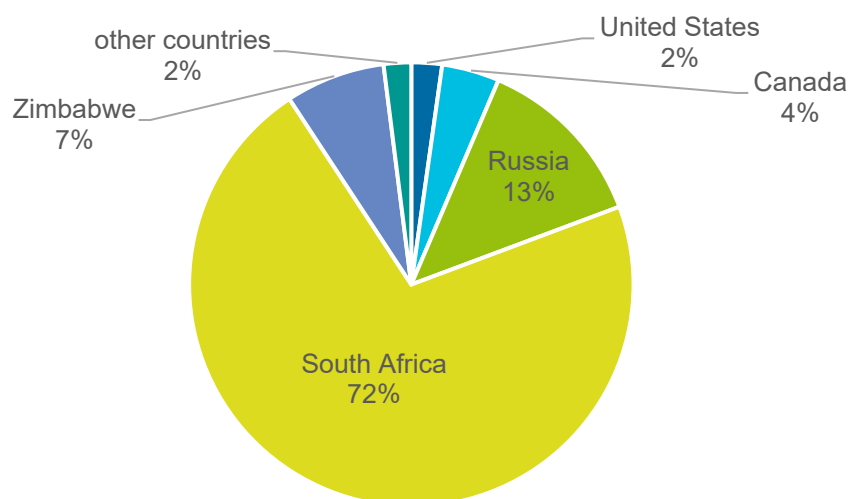

**Figure 47 Platinum – Share of world mine production 2019 [USGS 2021 A]**

In the case of palladium, world mine production in 2019 totalled 227 tonnes [USGS 2021 A]. As can be seen from the Figure 48, Russia (43 %) and South Africa (36 %) together covered the bulk of world mine production of palladium in 2019 [USGS 2021 A].

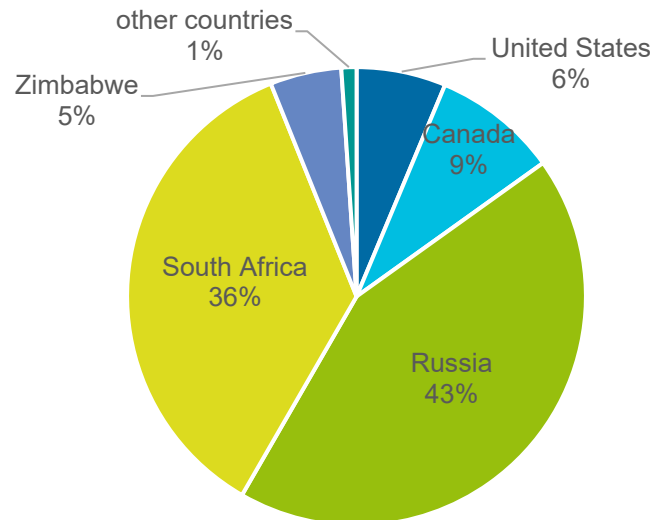

**Figure 48 Palladium – Share of world mine production 2019 [USGS 2021 A]**

Due to the outstanding importance of South Africa and Russia for primary extraction of platinum and palladium, the following explanations on to identify ecological and social ‘hot spots’ of raw material extraction and processing focus on these two countries.

#### 4.1.2.1 PGM mining in South Africa

The ore content of PGMs in primary mines is typically very low, at 5 to 10 g/t. Depending on the deposit, the proportion of individual PGMs varies greatly. Russia and the USA have higher Pd grades, while South Africa has higher Pt grades. PGMs are produced as a primary product in South Africa. The main South African deposit in the Bushveld Complex, the 'Merensky Reef' that dominated South African production for a long time since its discovery in 1925, consists of a magmatic intrusion more than 100 km long (with a Pt:Pd ratio of about 2.5:1), and the ore is mined underground at a depth of about 1 000 m [Hagelüken 2005]. In the first stages, the raw ore is processed by fine grinding and flotation. In multi-stage pyro-metallurgical processes, the PGMs are concentrated together with non-ferrous metals such as copper and nickel.

After a series of further process steps, such as desulphurisation, slag separation and slow cooling of a microcrystalline metallic Ni-Co-Fe phase, the PGMs are further concentrated. This PGM-rich phase is further concentrated by milling and magnetic separation and non-ferrous metals are largely removed by pressure leaching with  $H_2SO_4/O_2$ . The remaining PGM concentrate (40 %-90 %) is the raw material for further refining and hydrometallurgical purification [Hagelüken 2005].

Mining has a long tradition in South Africa and is an important economic activity for the country. Coal, gold and platinum group metals are important examples of mined minerals in South Africa. However, the mining sector in South Africa is often associated with social tensions. These are not least linked to South Africa's tense history; the effects of the apartheid era continue to have a negative impact today. As a result, the mining sector in South Africa is often affected by labour disputes and strikes

[Stoddard et al. 2012]. In the area of PGM extraction, the massacre of Marikana<sup>33</sup> in 2012 is a sad culmination of these ongoing social tensions and disputes [McClenaghan 2012].

In South Africa's platinum industry, the mining depths of around 1 000m also pose challenges for environmental protection and worker health. Energy-intensive ventilation and cooling systems are necessary, including the introduction of ice-from-surface into the deep mining galleries [Karsten et al. 2012]. Overall, a number of serious environmental impacts are described for the numerous processing steps (mining, rock crushing, milling, flotation and drying, smelting and refining), such as dust and sulphur dioxide emissions, chemical-laden flotation residues, water pollution and very high energy consumption [Cairncross 2014]. For one tonne of platinum, 580 000 tonnes of ore have to be mined and processed. The water demand is 400 000 m<sup>3</sup> on average per tonne of PGM and the greenhouse gas emissions range between 40 000 and 50 000 tonnes of CO<sub>2</sub> equivalent per tonne of PGM [Cairncross 2014]. In a comparative life cycle assessment of the production of 63 different metals, the platinum group metals and gold have the highest specific environmental impacts [Nuss et al. 2014].

The fact that many problems in South Africa's mining sector have not yet been solved, or at least not adequately, became clear not least from a recent speech by President Cyril Ramaphosa. Among other things, the President of South Africa stated that:

Mining companies should strive to incorporate and actively implement environmental, social and governance standards into all aspects of their business decisions and operations. [...] Mining leaders must confront and take decisive action to help the industry reduce fatalities, injuries and occupational diseases [Ramaphosa 2021].

#### **PGM (South Africa) assessment:**

PGM mining in South Africa, with a focus on platinum mining, still faces massive social problems, despite the government's commitment to sustainable mining. Similarly, the severe environmental problems resulting from PGM mining (high specific environmental burdens, major health challenges for workers) persist. All this is against the backdrop of a difficult social situation (consequences of apartheid) and a fragile energy infrastructure that so far relies mainly on hard coal (i.e. very polluting) for power generation.

*Disclaimer: an assessment is always dependant on the individual situation on the ground at any site. The evaluation presented here is based on a generalized summary of known common issues for a given raw material. No conclusion regarding specific mine sites can be drawn from this assessment.*

Environment: ● Social: ● Overall: ●

#### **4.1.2.2 PGM mining in Russia**

The Russian company Norinickel (until 2016 under the name Norilsk Nickel) is the largest palladium producer in the world. Besides palladium, other PGMs, such as platinum, iridium, ruthenium and

---

<sup>33</sup> The Marikana massacre represents the killing of 34 miners by the South African Police Service (SAPS) on 16 August 2012. The Marikana massacre occurred during a wildcat strike at a platinum mine owned by Lonmin in the Marikana area near Rustenburg in 2012.



rhodium, are also mined. Nickel and copper, along with several other precious and non-ferrous metals, are mainly produced [Norilsk Nickel 2020]. The main part of the ore is mined in Norilsk/Talnakh in Northern Siberia, Russia; the PGMs are produced as a by-product of nickel production extracted from sulphide nickel-copper ore [Hagelüken 2005].



**Figure 49 Quarry in Norilsk<sup>34</sup>**

Mining in the Norilsk region began as early as the 1920s. The history of Norilsk has been associated with extreme environmental pollution for decades [Marques 2020]. Since sulphide ores are smelted on site and emission reductions are so far insufficient, the site is considered one of the world's largest point sources of sulphur dioxide emissions. Recent publication extrapolated Norilsk's annual sulphur dioxide emission to an average of 1.86 million tonnes [Raputa e al. 2019]. In addition to sulphur dioxide, there are also considerable dust emissions, including emissions of nickel and copper, as well as massive water pollution [Luhn 2016, Marques 2020].

Notwithstanding the relatively high wage level for Russia, the social circumstances in Norilsk are considered critical. This applies both to the local social infrastructure and to the environmental conditions [Krivosheev 2021]. Furthermore, the indigenous inhabitants of the region are massively affected in their livelihoods by Norilsk's activities and therefore also demand that the company's western customers resolutely demand good environmental and social standards from Norilsk in the future [Holzman 2020, Stone 2020].

---

<sup>34</sup> Quarry Bear stream, Norilsk by Nikolay Zhukov licensed under CC BY 3.0, , <https://imagedu.edu/view/13949/> (15.02.2021).

## **PGM (Russia) assessment:**

The environmental impact of PGM mining in Russia, in particular palladium extraction by Nor Nickel (until 2016 Norilsk Nickel), must be classified as high, despite efforts by the company and the government to mitigate the damage. Severe environmental damage has been proven to have occurred. A transformation to production with significantly lower environmental impacts requires considerable financial investments, and the implementation periods are currently not foreseeable. The massive environmental impacts also contribute to social tensions with the indigenous population, which should not be underestimated, nor should the difficult social environment in Norilsk itself.

*Disclaimer: an assessment is always dependant on the individual situation on the ground at any site. The evaluation presented here is based on a generalized summary of known common issues for a given raw material. No conclusion regarding specific mine sites can be drawn from this assessment.*

Environment: ● Social: ● Overall: ●

## **4.2 Key raw materials for EV**

### **4.2.1 Lithium**

The lightweight metal lithium (Li) has recently attracted worldwide attention as one of the key elements of lithium-ion batteries. While low concentrations of lithium are present around the world in seawater, extracting enough Li from the oceans to meet current demands is a slow and therefore inefficient process. Instead, the increasing demand for lithium is currently fulfilled by extracting it from two main primary sources and regions: continental brines, found mainly in South America; and hard-rock mining, mainly done in a few Australian mines [USGS 2020 A]. The largest lithium reserves are concentrated in Chile (approx. 50 % of global estimates) and Australia (over 15 % of global estimates), with the majority of production since 2018 coming from Australia [USGS 2020 A, Agusdinata et al. 2018] (see Figure 50 below). Extracting lithium from these primary sources carries distinct social and environmental concerns.

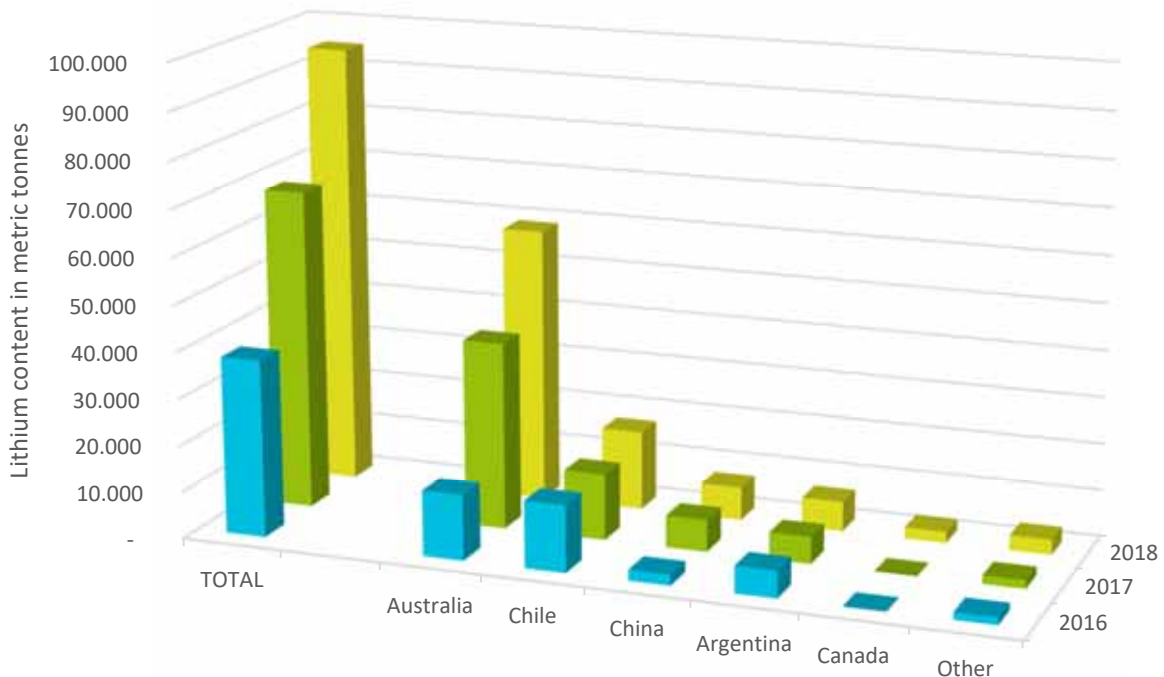

(data source: USGS 2020 A, USGS 2019 B, USGS 2018)

**Figure 50 Global lithium production (metric tonnes of lithium content) by country, 2016-2018**

#### 4.2.1.1 Lithium brine-mining in South America

Commercially viable concentrations of lithium are extracted from continental salt flats in the ‘Lithium Triangle’, which covers parts of Argentina, Bolivia, and Chile. According to recent geological surveys, the Lithium Triangle overall holds more than two thirds of global lithium reserves [USGS 2020 A, Agudinata et al. 2018]. Chilean lithium mining dominated the lithium market for several years leading up to 2018, at which point Australian mining took the lead. In stark contrast to its Lithium Triangle neighbour, Bolivia currently reports no large-scale lithium extraction efforts, although it has more than twice the resources; the country is often seen as an upcoming global player in the lithium value chain [USGS 2020 A, BGS 2020]. However, the brine at the Salar de Uyuni (Bolivia) has high levels of magnesium, making it more expensive to produce lithium when compared to other brines, such as the Salar de Atacama in Chile [Lombrana 2018]. Environmental and social issues with extraction of lithium from brines are mostly related to water scarcity.

Traditional brine mining for Li requires evaporating the water out of a hyper-saline solution, typically from reservoirs beneath or around salt lakes found in arid climates like in the Lithium Triangle. In this mining process, brine is pumped to a basin and left for up to 16 months as the sun slowly evaporates the water away [DERA 2017]. The lithium chloride concentrate, along with other salts and minerals, can be collected and further refined [Schueler et al. 2018]. Through this process, the evaporated water is removed from the surrounding land and lithium is concentrated into salts that can be transported for processing into battery cells and other materials.





**Figure 51 Lithium salt extraction from salt lakes<sup>35</sup>**

Although solar evaporation is a naturally occurring process, when water volumes are removed that are larger than would normally occur, the excessive water loss can impact the natural water cycle of an entire region [Rodrigo et al. 2009]. Research is still underway, with conflicting results, to understand the hydrology in regions where traditional brine mining takes place and to measure the extent to which salt lakes link with other water sources [Frankel et al. 2016]. Water removal in these regions has been documented to affect agriculture, such as livestock grazing or crop production, which indicates an impact on the local ecosystem [Pure Energy Minerals 2017].

Salt lakes are formed in arid climates; therefore, brine mining occurs in regions where water is scarce. Consuming this life-critical yet scarce resource through mining adds tensions on the limited and very essential water supply in these regions [Friends of the Earth Europe 2013, Frankel et al. 2016]. As a UN expert group indicated already in 2010, “the extraction of lithium through evaporation of brines in salt flats can have significant impacts on the often-delicate balance of limited fresh and/or ground water” [DESA 2010]. The group consequently recommended ‘comprehensive environmental

<sup>35</sup> Picture “20170809 Bolivia 1505 crop Uyuni sRGB” by Dan Lundberg, licensed under CC BY-SA 2.0, <https://www.flickr.com/photos/9508280@N07/37980063931/in/photolist-Yzii4R-2g5DKwy-ohRG7R-8VT8yi-6arXby-6anAWe-8qNChk-6anAWc-8qNC4p-FVAXce-ZSaJt4-ZMstLE-8qRJmm-FVB1Vr-8qRUiL-aCj9u6-8qRU5f-aCjb2Z-ho-gAQL-8qNNbt-8qRUHm-8qNBJe-oDrCNL-8qRTT9-8qRUbd-ZSaEkV-8qNNkK-FVAWt-8qRTYL-8qRUMs-8qRJ41-8qNBXk-ZMs9W5-8qRJf-8qNCrg-ZMrCG-ZSaK1X-ZMspgN-ZMsskJ-ZSaKNt-ZSaLcz-ZMstiq-4WYtB6/> (21.12.2020)

impact assessment studies and monitoring to prevent, minimize and mitigate any negative impacts on the flora, fauna and ecosystems in the salars and the adjacent area' [DESA 2010].

Other social and environmental issues also arise with traditional brine mining. Lithium is not the only mineral present in the brine; other dissolved chemicals may require proper handling and disposal when they are concentrated through the mining process. Improper waste disposal can pollute the scarce water sources in the region, thereby also further complicating social issues with the water supply. Health and contamination issues with dust arise when the concentrated, lithium-containing residues left after evaporation are blown into the surroundings. As well, economic losses of the lithium chloride concentrate from wind can reportedly reach up to 40 % of the expected lithium recoveries [DERA 2017].

As found with many mining techniques, brine mining in the Lithium Triangle is also associated with destruction of unique landscapes and natural habitats. For example, Bolivia's Salar de Uyuni boasts a unique natural landscape of salt lagoons that hosts a unique biodiversity. The water resources in this fragile ecosystem, one of the most arid in the world, are considered to not be renewable (or only extremely slowly). This means that regional brine mining is associated with risks for negative environmental impacts [Rodrigo et al. 2009].

Research and efforts are underway to incorporate water conservation techniques into brine mining. In an optimisation of traditional brine mining methods, the evaporated water can be recovered through closed evaporation circuits and pumped back into the salt lake or underground reservoirs [Ezama et al. 2018]. This closed system also increases the recovery rate of lithium by more effectively trapping lithium dust, and it reduces extraction times from months to hours [DERA 2017].

The history and collective memory of negative experiences from mining in South America over the past decades and centuries continue to provoke resistance to the mineral extraction sector. The social license to operate (SLO) in some regions is in question and will require real commitments to changes in mining practices for SLO to be fully gained [Austrade 2020]. Existing political and social conflicts in some South American countries further complicate efforts to promote improvements and make changes in mining practices.

Developing local value chains for lithium production is seen as one way to gain general acceptance. As well, steps towards more transparency from the industry are already being taken. SQM, a large Chilean lithium brine miner in South America, operates an open monitoring platform where up-to-date information on hydrogeological issues, among other topics, is publicly accessible [SQM 2018].

#### **4.2.1.2 Australian hard-rock mining of lithium**

In the span of just a few years, from 2016 to 2018, Australia significantly increased its lithium production from hard-rock mines. Until 2018, brine production of lithium dominated the primary lithium supply due to lower production costs; as part of the Lithium Triangle, Chile was the world's leading lithium producer. But from 2016 to 2017, Australian lithium production tripled, and in 2018 it again increased by nearly 50 % over the previous year. As a result, since 2018 Australia produces over half of worldwide primary lithium from its hard-rock mines [Dolega et al. 2020].

Australian lithium mining is concentrated in a few mines in the Yilgarn and the Pilbara Cratons [Champion 2019]. The largest example, the Greenbushes mine in the Yilgarn Craton of south-west Australia holds the largest hard-rock lithium deposit in the world. It produces the most lithium

of any hard rock mine worldwide, from spodumene ( $\text{LiAlSi}_2\text{O}_6$ ), a pegmatite rock deposit with extractable grades of lithium [Champion 2019]. Not only does Greenbushes have the largest hard-rock lithium reserves, it also boasts an exceptional grade of spodumene that exceeds 3 %  $\text{Li}_2\text{O}$  [Dessemond et al. 2019, Evans 2014].

At the Greenbushes mine, spodumene is extracted in open pits from freshly exposed areas of pegmatite. The exposed ore is sorted and stored by grade, with waste material kept in specific areas of the mine until they can be replanted according to the mine's rehabilitation plans [Talison Lithium 2021]. Further processing also takes place at the mine's three processing plants. The sorted spodumene is processed –through crushing and grinding; concentration using gravity separation, magnetic separation and flotation; and dewatering [Dessemond et al. 2019, DERA 2017] – to allow shipment of lithium concentrates of technical or chemical grades [Talison Lithium 2021].

Spodumene is commonly processed through acid roasting to extract lithium carbonate. The ore is heated to at least  $1000^\circ\text{C}$  for 30 minutes and then hot sulfuric acid and other chemical solutions are used to precipitate out the lithium carbonate ( $\text{Li}_2\text{O}$ ) and remove contamination [DERA 2017, Dessemond et al. 2019, Evans 2014]. New processing methods seek to instead extract lithium hydroxide monohydrate ( $\text{LiOH}\cdot\text{H}_2\text{O}$ ) from the spodumene ore through pyrometallurgical and hydrometallurgical processes that also involve high heat and injection of strong acids and other chemical solutions [Simpec 2020, Albemarle 2018].

As with any hard-rock mining and processing operation, many environmental risks must be mitigated to ensure a safe site. The environmental impact of open pit mining is firstly visible, as it cuts into landscapes. Hard-rock mining and processing is also very energy intensive, especially when compared to brine mining. Depending on the energy sources used (fossil fuels, coal and/or renewable energy), this energy demand can be a significant factor in evaluating a mine's specific environmental impact.

Pollution resulting from mining practices is generally always a risk. Spodumene ore produce wet residues called 'tailings', that may contain concentrated levels of toxic metals or other chemicals. These wastes are commonly stored in tailings storage facilities (TSF) at the mining site and must be maintained properly to prevent leaks and environmental contamination [Dolega et al. 2016]. Severe accidents can occur, for example when the dam of a TSF breaks or when contaminated water or other chemicals leach into the groundwater.

Social issues in local communities that result from mining activities pose another area of concern. For Australian mining, such social impacts, like environmental impacts, are in part managed at a higher level; the national government of Australia maintains high work-safety standards and offers above-average mining salaries. As well, child labour or artisanal and small-scale mining (ASM) do not occur in Australia [Dolega et al. 2020]. Social issues can arise when mining takes place on Aboriginal lands or sacred sites (e.g. see [Albeck-Ripka 2020]). The Australian mining industry is nonetheless a significant employer of aboriginal people. Some Australian mining companies, for example Pilabara Minerals Limited, give preference to hiring aboriginal people and procuring services from aboriginal-run businesses [NAIF 2018]. The remote locations of Australian mining can as well put stress on workers, who cannot permanently reside near their place of work. The social impact of 'fly-in/ fly-out' work means that employees are absent from their families for long periods. This can increase their risks for mental health issues, family conflicts and substance abuse [Langdon et al. 2016].

The two main methods for lithium extraction have very different challenges regarding social and environmental impact. Australian hard-rock mining practices, though strongly regulated for the most publicized environmental and social impacts, have broader environmental concerns when their energy consumption is considered. While much less energy intensive, brine mining in Chile, Bolivia and Argentina faces social and environmental issues related to water consumption and potential environmental contamination. While Australian production currently dominates the lithium market, South American production is foreseen to gain market momentum, while the environmental and social issues need to be addressed and mitigated in parallel.

**Lithium, assessment:**

The two main sources of lithium – hard rock mining in Australia and lithium extraction from brines in South America – impact the environment. While hard-rock mining is associated with the general risks of a metal mine (land disturbance, heavy metal pollution, re-cultivation etc.), brines face issues with water scarcity in an arid region. The environmental risk is therefore evaluated to be medium. From a social perspective, Australian hard-rock mining is associated with low risks. Social tensions have been reported due to lithium mining in South America and therefore pose a medium risk. Overall, the risk connected to lithium mining is estimated to be medium.

*Disclaimer: an assessment is always dependant on the individual situation on the ground at any site. The evaluation presented here is based on a generalized summary of known common issues for a given raw material. No conclusion regarding specific mine sites can be drawn from this assessment.*

Environment: ● Social: ● Overall: ●

#### 4.2.2 Cobalt

Currently used Li-ion batteries such as NMC<sup>36</sup> or NCA<sup>37</sup> as well as LCO<sup>38</sup> depend on cobalt. Although the trend to reduce the cobalt content per battery cell persists, the overall market growth will go hand-in-hand with an increasing demand. While Li-ion batteries today are the main application for cobalt, other fields are also important. Cobalt is used in a variety of superalloys and as an alloying element in tool steel. Other important fields of application are the pigment industry and the use of cobalt as a catalyst in the petrochemical industry (compare chapter 3.1 ) and, due to its ferromagnetic properties, as a magnetic material. Most of the applications show significant growth rates, although the market for lithium-ion batteries is growing about twice as fast [BGR 2020].

Compared to other commodities, the metal has a very monopolistic supply structure regarding production countries. In 2018, the global primary production was 148 000 tonnes. The majority was produced in the Democratic Republic of the Congo (DRC), amounting to more than 70 % of global supply (104 000 tonnes). The rest of the production is distributed among several countries, with Australia (4 880 tonnes) and Russia (6 100 tonnes) being the most important [USGS 2020 A].

---

<sup>36</sup> Lithium nickel manganese cobalt oxide

<sup>37</sup> Lithium nickel cobalt aluminium oxide

<sup>38</sup> Lithium cobalt oxide

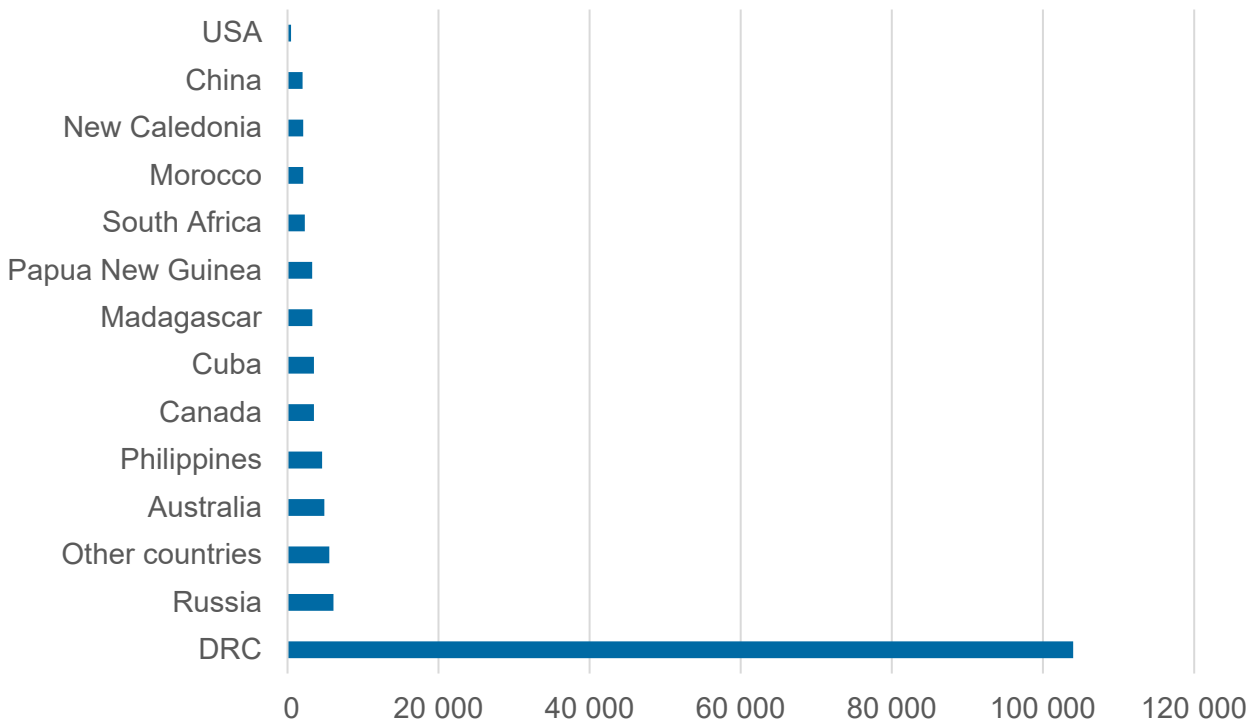

**Figure 52 Cobalt mine production by country in 2018, in tonnes [USGS 2020 A]**

Cobalt is mined mainly in large operations as a by-product of copper and nickel production. To date, only one modern, large-scale mining operation (Bou-Azzer, Morocco) extracts cobalt as its main product, accounting for about 1.4 % of world production [Shedd et al. 2017]. One of the key issues often discussed in relation to cobalt is artisanal and small-scale mining. In the DRC around 20 % of the production is estimated to be mined by small scale miners.

**Artisanal and small-scale mining (ASM)**

Artisanal and small-scale mining (ASM) describes the extraction of ores with minimal or no mechanization, which is often done informally. ASM miners can be individuals, groups, families, or cooperatives [Hentschel et al. 2003]. In the DRC, this form of mining is very common in the cobalt sector. It is estimated that between 100 000 and 200 000 people are involved in the ASM sector depending on the cobalt prices. Due to the negative price development following the price peak in 2018, the numbers are declining and are currently estimated to be below 100 000 people [BGR 2020]. Estimates for material produced in the DRC by ASM miners vary between 15 % and 20 %. This amounts to more than 10 % of world production [Al Barazi et al. 2017]. Since small-scale mining is so labour intense, it generates many more jobs than large-scale industrial mining. In contrast to ASM, Glencore, the largest cobalt mining company, employs only ca. 15 000 workers including subcontractors in all its operations in the DRC [Industrial Global Union 2018].





**Figure 53 Example of an artisanal mine<sup>39</sup>**

In most cases, ASM is carried out informally without a legal permit. A major issue is the insufficient level of work safety standards that cause many accidents. Mine workers can also suffer from long-term lung illnesses due to exposure to dust [Schueler et al. 2018]. The miners often extract high grade cobalt ores in relatively low depths. To reach the ore near surface underground tunnels of up to 80 meters deep are dug using manual tools only [BGR 2020]. The shafts are very dangerous since they are insufficiently secured causing them to collapse frequently. Most importantly, ASM is often linked to child labour [Schueler et al. 2018]. Tsurokawa et al. [2011] estimated that around 28 % of the workforce in the Copperbelt are children under the age of 15 years. Although younger children are mainly involved in doing lighter tasks like sorting the ore, small children also extract ore in narrow galleries, which is regarded as one of the worst forms of child labour.

As the sector is strongly linked to price developments, ASM miners can absorb short-term demand peaks [BGR 2020].

### **By-product**

Being mainly a by-product of copper and nickel, cobalt is highly influenced by their market development. According to reports [BGR 2020], 56 % of cobalt production came from copper mines and 28 % from nickel mines. In the DRC, cobalt mining relates to copper deposits, while cobalt as a by-product of nickel is mostly extracted from magmatic sulphide deposits in e.g. Russia, Australia, and Canada [Schueler et al. 2018]. As cobalt is mainly a by-product, the assessment of the environmental and social challenges of mining is closely linked to those of copper and nickel [BGR 2020]. In this

<sup>39</sup> "Child labor, Artisan Mining in Kailo Congo" by Julien Harneis is licensed under CC BY-SA 2.0 ([https://commons.wikimedia.org/wiki/File:Child\\_labor,\\_Artisan\\_Mining\\_in\\_Kailo\\_Congo.jpg](https://commons.wikimedia.org/wiki/File:Child_labor,_Artisan_Mining_in_Kailo_Congo.jpg)) (21.12.2020)



brief overview, the focus is on the cobalt deposits associated with copper. Nickel-specific challenges are addressed in chapter 4.2.3.

### Acid Mine Drainage (AMD), heavy metals & radioactivity

Acid Mine Drainage (AMD) can pose significant risks when mining copper-cobalt ores since they are often associated with sulphide minerals. AMD takes place when sulphide minerals that are part of waste rock or tailings are exposed to oxygen and water, resulting in a chemical reaction that forms sulfuric acid. The acid dissolves heavy metals such as arsenic, cadmium, mercury or lead and can contaminate groundwater and soil if no adequate precautions are taken [Dolega et al. 2016]. Generally, AMD can also occur without anthropogenic influence when sulphide minerals are present. However, the mining process involves the crushing and grinding of ore and gangue material. Therefore, the surface of the minerals is significantly increased allowing for a much faster formation of AMD.



**Figure 54 Example of acid mine drainage<sup>40</sup>**

Moreover, heavy metal contamination is a problem in the Copperbelt region. Toxic pollution is inherently connected to cobalt and copper mining since the ore is associated with various heavy metals. Moreover, copper and cobalt are heavy metals themselves. Case studies in the Copperbelt reveal that heavy metal pollution is high in the direct vicinity of mines and distribution via waterways affects larger areas [Ikenaka et al 2010].

Many copper-cobalt ores from the Copperbelt are associated with elevated levels of uranium [Al Barazi et al. 2017, Tsurukawa et al. 2011]. In 2018, cobalt exports and sales at the Kamoto copper-

<sup>40</sup> “Ohio Valley Mushroom Farm Site in North Lima, Ohio” by Jack Pearce is licensed under CC BY-SA 2.0 ([https://commons.wikimedia.org/wiki/File:Ohio\\_Valley\\_Mushroom\\_Farm,\\_Acid-Mine\\_Drainage\\_\(AMD\)\\_13670979525.jpg](https://commons.wikimedia.org/wiki/File:Ohio_Valley_Mushroom_Farm,_Acid-Mine_Drainage_(AMD)_13670979525.jpg)) (22.01.2021)

cobalt mine were suspended after uranium in cobalt hydroxide exceeded allowed limits for export [Jasmamie 2018].

### **Price dependence**

Following the price peak in 2018, cobalt prices dropped. In December 2018, the DRC government decided to increase the production tax on exports of cobalt ore and crude hydroxide from 3.5 % to 10 %. This influenced the profitability of some mines. Glencore's largest copper-cobalt mine Mutanda has been put under care and maintenance for an initial period of two years, following the decision to increase tax on exports [BGR 2020, Whitehouse 2019].

### **Tailings reprocessing**

The increasing demand for cobalt not least because of electric mobility also offers opportunities for reprocessing old tailings material. The Copperbelt region has a long history of mining and therefore older tailings often contain significant cobalt grades [BGR 2020]. The processing wastes are often abandoned and improperly stored, often in direct vicinity to cities like Lubumbashi or Kolwezi, where e.g. the volume amounts to 112 Mt of waste material with a grade of 1.49 % copper and 0.32 % cobalt. The reprocessing of old tailings could potentially help to cover the demand and generate tax income while simultaneously reducing the release of pollutants to waterways and soils [Lutandula & Maloba 2013].

### **Cobalt, assessment:**

The DRC is by far the largest cobalt supplier and will very likely remain so, since the country also holds by far the largest reserves. It needs to be clearly highlighted that large-scale industrial mining and artisanal and small-scale mining have very different impacts and are connected to other environmental and social impacts. Sometimes general statements regarding cobalt from the DRC mix the two and leave the impression that child labour is a problem with large mines as well, which is not the case. Overall, a medium to high risk is associated when looking at the environment. On the one hand, large scale mines do show signs of improvement; nonetheless, geological risks such as sulphide ores that pose an AMD potential are present. Moreover, abandoned mines and tailings have negative impacts on the environment that should be addressed by e.g. reprocessing tailings and re-cultivating the areas. ASM mines do not address this issue at all since they are informal to a large extent. As far as social issues are concerned, large mines are usually not associated with major problems on a regular basis. ASM, however, has issues concerning work safety standards and child labour. Formalisation of ASM could be a way to improve the situation. Overall, the social situation poses a high risk due to the large share of informal ASM.

*Disclaimer: an assessment is always dependant on the individual situation on the ground at any site. The evaluation presented here is based on a generalized summary of known common issues for a given raw material. No conclusion regarding specific mine sites can be drawn from this assessment.*

Environment:  Social:  Overall: 

### 4.2.3 Nickel

Nickel has gained attention in the last years as it is being used as one element in cathode materials for NMC batteries. Although still mainly used in the steel industry and alloys, batteries become increasingly more important. Currently demand is mainly driven stainless steel which covers 74 % of demand, followed by alloys 21 % and batteries 5 % [Azevedo et al. 2020]. Nickel demand for batteries will increase not least due to the trend to reduce the cobalt content in the cathode while simultaneously increasing the share of nickel.

Global primary nickel production is well diversified (compare Figure 55). In the last years, Indonesia became the largest supplier, producing more than 600 000 tonnes representing ca. 25 % of global production followed by the Philippines with more than 345 000 tonnes covering 14 % of the output. Russia and New Caledonia are also large suppliers, producing 272 000 tonnes (11 %) and 216 000 tonnes respectively (9 %). Moreover, Canada and Australia each produce around 170 000 tonnes corresponding to 7 % of the global production. Accordingly, the market is not dependant on a specific country.

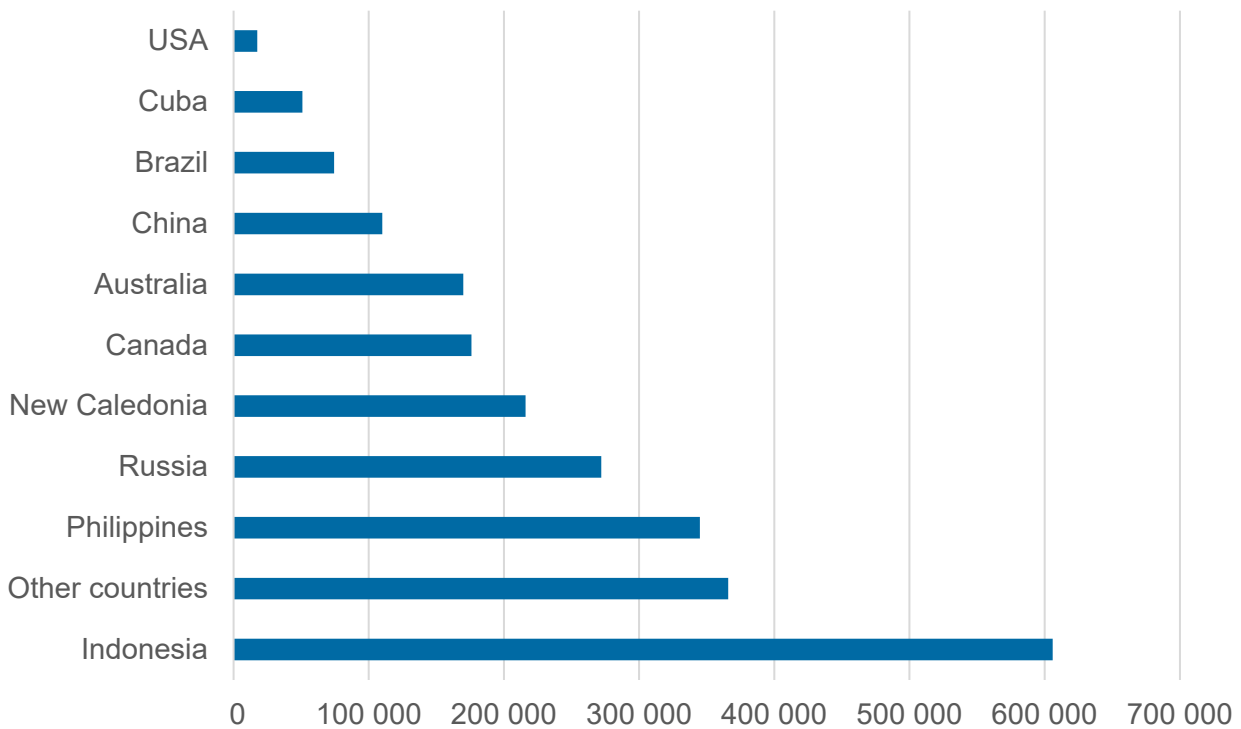

**Figure 55 Nickel mine production by country in 2018 in tonnes [USGS 2020 A]**

Total global nickel reserves amount to 88.7 Mt and are also distributed among a variety of countries. Indonesia and Australia together cover around half of all reserves, followed by Brazil where 12 % are located. Moreover Russia, Cuba and the Philippines hold significant reserves [USGS 2020 A] (compare Figure 55).

Nickel is extracted from sulphide and lateritic deposits in approximately equal shares [Buchert et al. 2017]. In the past, global production was dominated by sulphide ore mining, while an increasing shift towards lateritic deposits was observed. Processing sulphide ores is easier since it involves conventional mining, smelting, and refining. Lateritic deposits on the other hand require hydrometallurgical processing, increasing production costs. These difficulties have led to a historical preference for exploiting sulphide deposits [Mudd 2009].

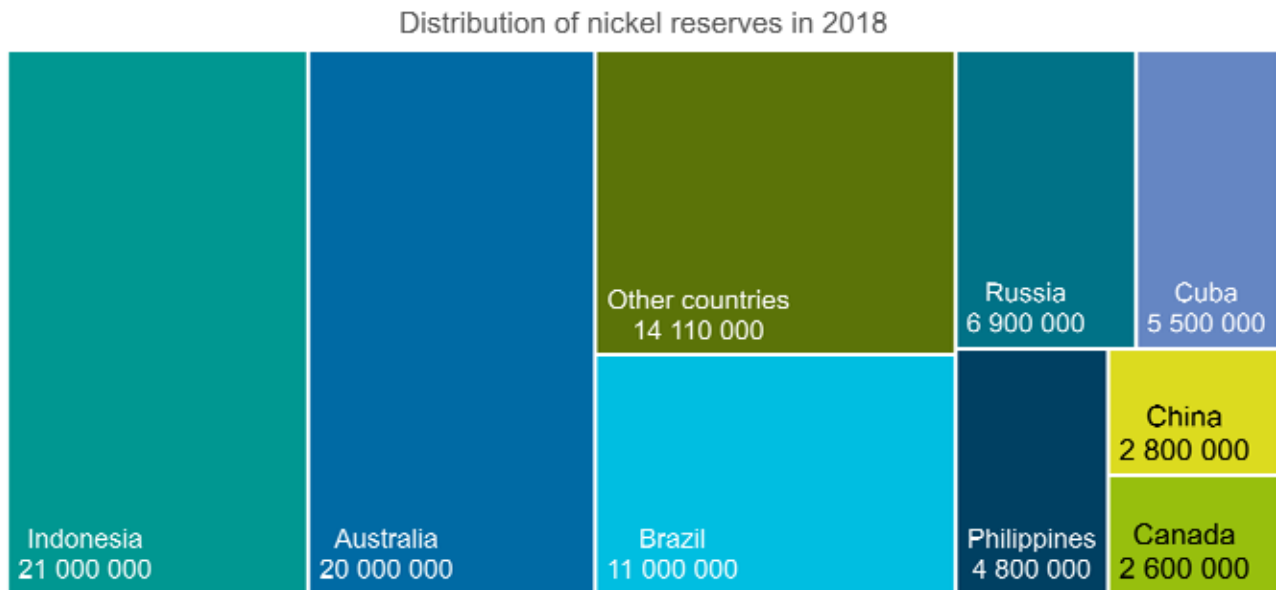

**Figure 56 Nickel reserves by country in tonnes in 2018 [USGS 2020 A]**

Sulphide ores are formed by volcanic and hydrothermal processes. Nickel sulphide ores are often associated with copper and cobalt and sometimes PGMs or gold. They are mined both in open-cut and underground mines. Mining is followed by concentration via flotation, smelting of concentrates and refining [Mudd 2009]. The potential for AMD generation when mining nickel sulphide deposits is high [Dehoust et al. 2020].

Laterite deposits are always mined in open cuts since the ore deposits are shallow and spread over large areas. Mining and beneficiation are followed by high pressure acid leaching, where the mined nickel ore is leached with sulfuric acid under high pressure and high temperatures. Then the metal-rich solution goes through a hydrometallurgical solvent extraction. Afterwards, either metal is produced or nickel hydroxide or sulphide. Cobalt is extracted as a by-product in all lateritic nickel mines [Mudd 2009].

Comparing from an environmental perspective the two types of nickel mining and the involved steps it becomes clear that laterites have some disadvantages over sulphides. The energy required to produce one tonne of metal from laterites is between 2.5 and 5 times higher than producing it from sulphides. Greenhouse gas emissions from laterite deposits range between 25 and 46 tonnes of CO<sub>2</sub> per tonne of primary metal. In contrast, sulphide ore mining results in only 10 tonnes of CO<sub>2</sub> per tonne of primary metal [Mudd 2009, Mudd 2010]. To separate nickel from other materials, it is smelted, meaning that the ore is heated. During the process, the contained sulphur oxidizes form sulphur dioxide [Fioletov et al. 2016].

SO<sub>2</sub> emissions from nickel mining play a significant role in the environmental impact of nickel. One of the largest nickel mines in the world is in Norilsk<sup>41</sup>, Russia. According to a Greenpeace report, it is the single largest source of anthropogenic SO<sub>2</sub> emissions with 1 898 kt in 2018 [Greenpeace 2019]. Supporting this, a report by Fioletov et al. [2016] argues that most SO<sub>2</sub> emissions from smelting are related to copper, nickel, and zinc.

<sup>41</sup> Norilsk does not only produce nickel, also copper, PGMs and cobalt are by-products.



Lateritic nickel deposits are formed by weathering of ultramafic rocks. Since weathering is a key component in their genesis, they are mostly located in tropical areas with high temperatures and rainfall [Mudd 2010]. Accordingly, the deposits are in areas with high biodiversity and dense vegetation. Particularly Indonesia faces the conflict of increasing nickel mining in high biodiversity areas in the tropical rainforest [Mudd 2010]. Moreover, habitat fragmentation and reduction can have significant negative impacts on biodiversity as the reduction of endemic conifers in New Caledonia because of nickel mining shows [Jaffré et al. 2010]. Following environmental concerns, 23 mines mostly producing nickel were shut down in the Philippines [Dela Cruz & Serapio Jr 2017].

#### Nickel export ban in Indonesia

Indonesia has been restricting the export of nickel in different forms since at least 2014; e.g. between 2017 and 2019, export of nickel ore with concentrations below 1.7 % Ni was allowed, while higher grades were restricted from export. Starting from January 2020, Indonesia completely banned the export of nickel ore. The Indonesian export ban requires mining companies to further process and purify the material prior to export, increasing the steps in the value chain [EC 2021]. The main reasons for the ban are the growing domestic nickel-pig-iron and stainless-steel industries, therefore increasing exports of higher added-value products [Durrant 2019, S&P Global 2020 C]. Indonesia also aims at increasing production of battery-grade nickel to meet rising demand for traction batteries [S&P Global 2020 C].

#### Nickel, assessment:

From an environmental perspective, nickel mining does not differ significantly from other metals. The key aspects of different deposit types have been described in the chapter above, considering e.g. the disturbance of areas, safety of tailings storage facilities, heavy metal contamination, dust emissions etc. Since no country has been in the focus in the assessment, the global supply mix is taken as a basis for evaluation. The environmental risks are evaluated as medium since they are comparable to other metal mines. Producing countries with good environmental governance include Australia or Canada but also countries that need to improve like Indonesia [EPI 2020]. No particular social concerns have been identified for nickel mining. Comparing governance indicators, a similar conclusion can be drawn as for the environmental performance [World Bank 2020]. Accordingly, the overall social and environmental risks is estimated to be medium.

*Disclaimer: an assessment is always dependant on the individual situation on the ground at any site. The evaluation presented here is based on a generalized summary of known common issues for a given raw material. No conclusion regarding specific mine sites can be drawn from this assessment.*

Environment: ● Social: ● Overall: ●

#### 4.2.4 Graphite

Lithium-ion batteries most commonly employ graphitised carbon, taking advantage of the exceptional electrochemical properties in such materials (e.g. high energy density and efficiency) that are available over a long lifetime. The two types of graphite – natural graphite (NG) and synthetic graphite (SG) – can be distinguished by their origins as well as their subsequent technical performance

profiles. While NG is mined and then purified, SG is synthetically produced by heating a carbon-based precursor. Although both NG and SG have similar chemical structures, their electrochemical behaviours and prices differ [USGS 2020 A]. SG always has the same quality and is more versatile in its use in the final anode material, but it is also more expensive. Their different origins also imply different environmental impacts [Dolega et al. 2020].

Most NG is mined in China (over 60 % of world production in 2019) [USGS 2020 A]. Indeed, China is very interested in graphite for its own battery industry, and low levels of Chinese environmental regulations make Chinese NG processing comparatively cheap [Robinson et al. 2017]. Combatting this market dominance, other countries, in particular Mozambique, have been increasing their NG mining [USGS 2019 B, USGS 2020 A]. As of 2018, Mozambique boasted the second largest graphite production through mining worldwide, with approximately 9 % of market share [USGS 2020 A]. Most of its NG comes from the Balama mine, the largest NG mine in the world in terms of annual production capacity.<sup>42</sup> While such global market-share figures of NG mining cover the total amount of NG used in all industries, the market share of NG anode material that China produces is even higher than its mining share for NG [Pillot 2019].

Although the synthetic production of SG makes it more expensive, SG market shares are predicted to continue to increase over those of NG. SG has a comparably high purity level and smaller quality range compared to NG, making it more dependable for use in EV batteries [Schmuck et al. 2018]. As [Pillot 2019] reports, the market share of lithium ion battery anode materials in 2018 was dominated by SG, with a market share of about 56 % compared to only approximately 35 % for NG in 2018 (Amorphous carbon, silicon composites and lithium titanate fulfilled the remaining share [Pillot 2019]).

The environmental impacts from producing graphite (both SG and NG) are mainly related to the strength of ecological regulations monitoring mining and processing and to the energy sources feeding the production processes. SG production requires high amounts of energy and involves lengthy processes. Several weeks are needed for the calcination, graphitisation, and cooling processes, during which time the materials must be heated to  $\geq 2500$  °C before cooling [Gomez-Martin et al. 2018]. The energy sources for heating pose the most obvious environmental concern for SG. In contrast, producing NG for use in batteries requires extraction, separation, and processing to generate the necessary structure for graphitic anode materials – and with these activities come certain environmental and waste-related issues (e.g. groundwater pollution, waste production, excessive energy demand). Graphite, an inert substance, is itself non-toxic to humans and the natural environment. However, if not properly managed through environmental, health and safety (EHS) measures, the emissions and wastes from its mining or synthesis as well as processing can negatively impact health and the surrounding environment [USGS 2017].

Natural graphite is often extracted using open-pit mining, a more cost-effective extraction method than underground mining [USGS 2017]. Once extracted, the NG is separated from the surrounding matrix by mechanical separation followed by froth flotation. The graphite material is dried, screened and further crushed. It can then be processed into a “potato-shaped structure” necessary for making the graphitic anode.

NG can be cleaned in two main ways: chemically or thermally. The most common method for NG purification in China uses inorganic acids like hydrofluoric, hydrochloric, or sulphuric acid to chemically purify the graphite. A more costly and energy-demanding treatment to evaporate impurities involves heating the graphite powder in an inert gas atmosphere to over 3000°C. These purification

---

<sup>42</sup> <https://www.mining-technology.com/projects/balama-graphite-project/>, <http://www.syrahresources.com.au/overview>, both accessed on 14.12.2020

processes can be sequenced to generate an even purer form of graphite needed for special applications [Lämmerer et al. 2017, Dolega et al. 2020].

Mining and processing of NG are frequently associated with various ecological issues. In the often preferred open-pit extraction process, landscapes are destroyed [USGS 2017]. Furthermore, depending on the amount of NG in a mine deposit, the full NG production process, including mining through production of the NG anode, produces less than 5 % NG of the entire material [Lämmerer et al. 2017]. This means that a large amount of waste is generated. This waste may contain large amounts of rock that must be transported to landfills. This rock can itself be toxic if it contains, for example, uranium, nickel, or mercury [USGS 2017]. Some of the waste from the extraction process may contain other minerals (e.g. iron sulphides pyrite and pyrrhotite) that can cause groundwater acidification when exposed to water and air. Bringing these minerals to the surface when extracting the graphite can lead to serious environmental issues [Dolega et al. 2020].



**Figure 57 Open-pit mining corridor fragmenting the landscape<sup>43</sup>**

The physical separation of graphite ore from the surrounding deposit creates large amounts of dust that cannot be fully contained at the mining site. The National Institute for Occupational Safety and Health (NIOSH) of the U.S. Department of Health & Human Services reports that being exposed to graphite dust during mining can cause ‘coughing, dyspnoea (breathing difficulties), black sputum, reduced lung function and also pulmonary fibrosis, similar to coal dust’ [CDC 2019]. Whether these symptoms are caused by the graphite dust or other dust components, e.g. quartz, is not fully under-

<sup>43</sup> “Opencast at Craigman” by Robert Guthrie is licensed under CC BY-SA 2.0 ([https://commons.wikimedia.org/wiki/File:Opencast\\_at\\_Craigman\\_-\\_geograph.org.uk\\_-\\_863718.jpg](https://commons.wikimedia.org/wiki/File:Opencast_at_Craigman_-_geograph.org.uk_-_863718.jpg)) (21.12.2020)



stood [USGS 2017]. Other environmental studies addressing the impact of graphite dust on the surroundings, including houses, people and plants, do not indicate that the black dust hurts plant or animal life. Further studies are needed to fully evaluate these risks [USGS 2020 A].

Other issues arise when using flotation to refine NG, which leads to large amounts of tailings that need disposal. These tailings fill landfills and, depending on the mine composition, often require special management to prevent environmental contamination. Alternatively, some tailings may be used for other purposes, including as sand in concrete [Kathirvel et al. 2018].

The cleaning process for NG particularly raises environmental issues, since all the acids used in the process, especially hydrofluoric acid, pose a threat to the environment if released. Appropriate disposal of the residues from the chemical cleaning process must involve neutralising the acid with alkaline chemicals [SGL Carbon 2020, Roskill 2019]. Effective environmental legislation has been seen to mitigate these risks to the environment. However, in countries such as China that have lower levels of environmental regulations and insufficient penalties for non-compliance, cases of contaminated drinking water from graphite mining have been publicly reported [Washington post 2016]. In response to these problems and the resulting protests against the pollution, Chinese graphite mines were temporarily closed in 2013.<sup>44</sup> The subsequent measures have not appeared to have sparked major improvements, with further pollution issues around the graphite mines reported in 2016 [Washington post, 2016].

To avoid environmental contamination of groundwater stemming from the chemical cleaning process for NG, thermal cleaning could be used. While thermal cleaning is not seen to directly impact the environment, pollution results from the large amounts of greenhouse gasses (GHG) that are released from the power plants providing energy to heat the graphite particles.

Like thermal processing of NG, producing SG, or artificial graphite, requires a heat source and uses coal or other carbon sources as the feedstock. SG production begins with calcinating a carbon source such as petroleum coke or coal tar pitch, by-products from the oil or coal industries that are used in a variety of industries and only minimally for SG. Calcination of these carbon sources occurs in an inert atmosphere at lower temperatures (800°C-1200°C), producing an amorphous soft carbon. The resulting GHG emissions depend on how the furnace is powered (electricity or gas) [Dunn et al. 2015].

Once calcinated, the soft carbon is graphitised in an inert atmosphere. The SG production processes can take up to three weeks, during which time the materials must be maintained in special furnaces at 2500°C-3000°C for three to five days [Dunn et al. 2015]. Generating such high heat over a long period of time demands a large input of energy as electricity to power the furnace. The cooling process can be managed to allow some of the heat energy to be recovered [SGL Carbon 2020]. The resulting material needs to be further purified and processed in steps like NG processing – conditioning, grinding, classification and carbon coating – to produce the anode material needed for lithium-ion batteries [Dühnen et al. 2020].

Research is underway to investigate methods to reduce the environmental impacts and overall ecological footprint for producing battery-grade graphite. For SG, options exist to change its dependence on fossil fuels. Instead of using the currently common non-renewable feedstock of coal and oil-industry by-products, whose production is also associated with environmental hazards, biomass could be substituted. However, the comparatively low carbon densities in biomass vs. fossil fuel suggest

---

<sup>44</sup> <https://www.indmin.com/Article/3290097/Shandong-China-ordered-to-halt-flake-graphite-production.html>, accessed on 14.12.2020

that substitution would be less cost-effective and perhaps not impact overall emissions from the production process [Bengtsson et al. 2018].

The biggest environmental concern from SG production stems from the amount of electrical and heat energy required and the sources used to produce this energy. If renewable energies are used instead of coal or gas for power production, GHG emissions could be reduced. A shift in energy production methods is already employed by SG producers in the French Alps who use electricity from the nearby hydroelectric plants. For NG production, this change in energy source would not have as large of an impact, since most of the risks for pollution arise in procedures not directly related to energy consumption.

Yet, directly comparing the ecological footprints from NG and SG is not fully possible since the two types of graphite have different technical performance profiles and very different origins. A detailed assessment would be needed to quantify and compare the emissions from SG production with the impacts and emissions resulting from NG production. As the proportion of energy production from renewable sources increases over that from fossil fuels, it can be expected that the environmental impact from SG will continue to shrink. Likewise, the environmental impacts from NG can be expected to decrease as mining processes and controls continue to be developed and are more broadly instituted.

**Graphite, assessment:** Battery-grade graphite can be produced from natural or synthetic origins with certain ecological risks. Natural graphite (NG) production is associated with many risks that are common to mining. The methods for NG purification – chemically or thermally – also have environmental risks, many of which can be mitigated through processes and checks. Producing synthetic graphite (SG) also carries risks to the environment that largely stem from the choice of feedstock and energy sources used. These environmental impacts from SG can be significantly reduced through changes in energy sources; changing feedstock sources is not foreseen as a viable option for SG production. Focussing on China as by far the largest producer of graphite in general, the situation is still grave concerning environmental and especially social impacts.

*Disclaimer: an assessment is always dependant on the individual situation on the ground at any site. The evaluation presented here is based on a generalized summary of known common issues for a given raw material. No conclusion regarding specific mine sites can be drawn from this assessment.*

Environment: ● Social: ● Overall: ●

#### 4.2.5 Rare earths elements (REE)

According to the US Geological Survey [USGS 2021 B], world mine production of rare earth elements totalled 220 000 tonnes<sup>45</sup> in 2020. The figure below shows the shares of the main countries that contributed to world mine production of rare earth elements in 2019 [USGS 2021 B].

<sup>45</sup> Data in metric tonnes of rare-earth-oxide (REO) equivalent content.

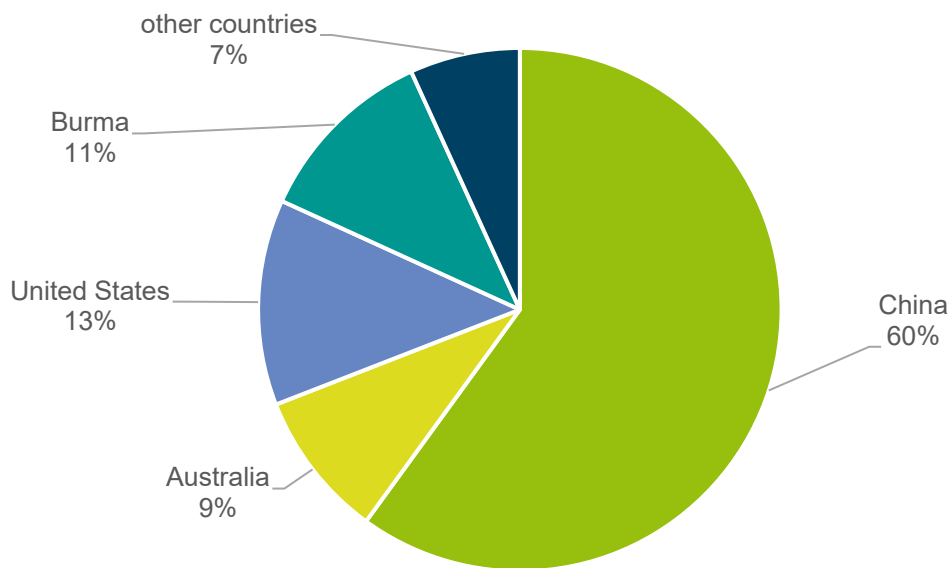

**Figure 58 Rare earths world mine production in 2019 [USGS 2021 B]**

China remains the leading nation in mining production of rare earth elements, with a 60 % market share<sup>46</sup>. This is followed by the USA with 13 %, Burma with 11 % and Australia with 9 % global market share in 2019 [USGS 2021 B]. The following discussion focuses on rare earth element extraction and processing in China, the main producing country.

### REE mining in China

The mining and complex processing of rare earth elements in China has been the subject of studies and media reports for years due to its considerable environmental impact. On the one hand, this applies to the world's largest rare earth mine, Bayan-Obo, China. Here, the release of radioactive<sup>47</sup> by-elements through dust emissions and huge pools of sludgy, toxic flotation residues are reported [Schueler et al. 2011, Haque et al. 2014]. The following graphical overview shows the most important environmental risks along the process chain that are frequently encountered in practice in China to date.

While mines such as Bayan-Obo (Inner Mongolia) mainly extract light rare earth elements such as neodymium, praseodymium, lanthanum and cerium, in other regions of China heavy rare earth elements, such as terbium or dysprosium, are often extracted through small-scale mining or even illegally through in-situ leaching of ion adsorption deposits [Cheng et al. 2010]. This does not involve classic surface or underground mining. However, the leaching chemicals also cause considerable environmental problems – in this case for the groundwater [Schueler et al. 2011]. These problems are now also increasingly evident in neighbouring Myanmar, which has taken on an important role in the supply of raw materials for China's rare earth industry [The Irrawaddy 2021].

<sup>46</sup> Production quota; does not include undocumented production.

<sup>47</sup> Natural radioactive by-elements such as thorium are found in almost all rare earth element deposits worldwide. The processing of the ores produces radioactively contaminated residues which, if not adequately covered, cause significant regional health hazards, especially in the form of dust emissions [Schueler et al. 2011].

Despite the efforts of the central government in China to solve the environmental problems associated with rare earth element mining and processing, the challenges are still very pressing today, as a recent assessment from China, published in China Daily shows:

However, the country's rare-earth industry faces problems such as smuggling, illegal mining and environmental damage issues [Zhihua et al. 2021].

Only recently, in Ganzhou, East China's Jiangxi Province, about 40-50 per cent of the rare earth enterprises there were temporarily shut down due to serious environmental problems [Global Times 2021].

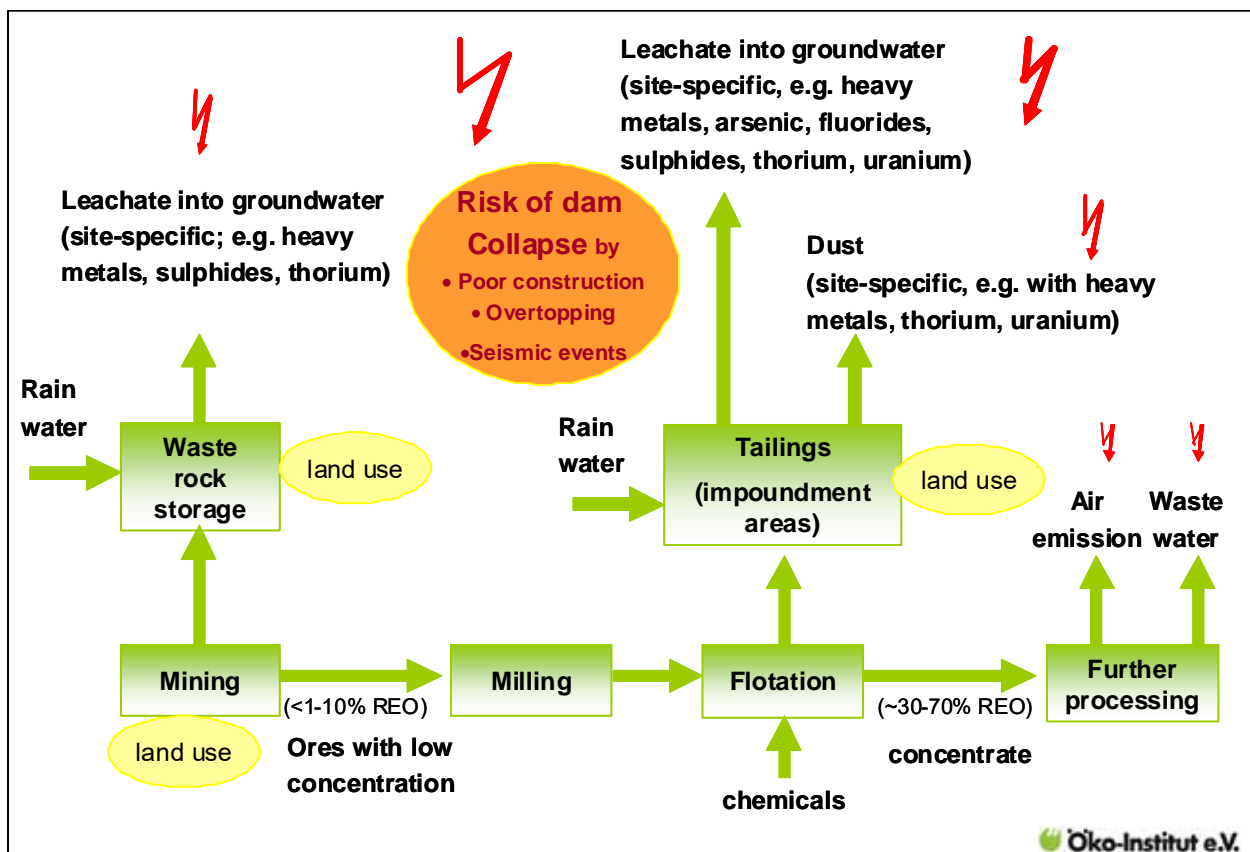

**Figure 59 Risks of rare earth mining with or without insufficient environmental protection systems [Schueler et al. 2011]**

Furthermore, significant social and societal problems are associated with the considerable environmental impacts of rare earth element extraction and processing in China. Local resident groups were negatively affected in a massive way, as agricultural activities became impossible due to the extraction and processing of rare earth elements. This led, for example, to massive migration, as living conditions were no longer bearable for the people [Saleem 2014]. In general, the health impacts on the residents are considerable – caused by the substantial amounts of chemicals used. Particularly the toxic and radioactively contaminated dusts, which are produced at the edges of the tailing ponds pose a threat to health and the environment. This issue is of high relevance in the arid regions of Inner Mongolia, placing a heavy burden on the region and the people living there. Among other issues, cancer deaths are reported [Kaiman 2014]. The following illustrates the extent of radioactive contamination using the example of the Bayan-Obo extraction site.

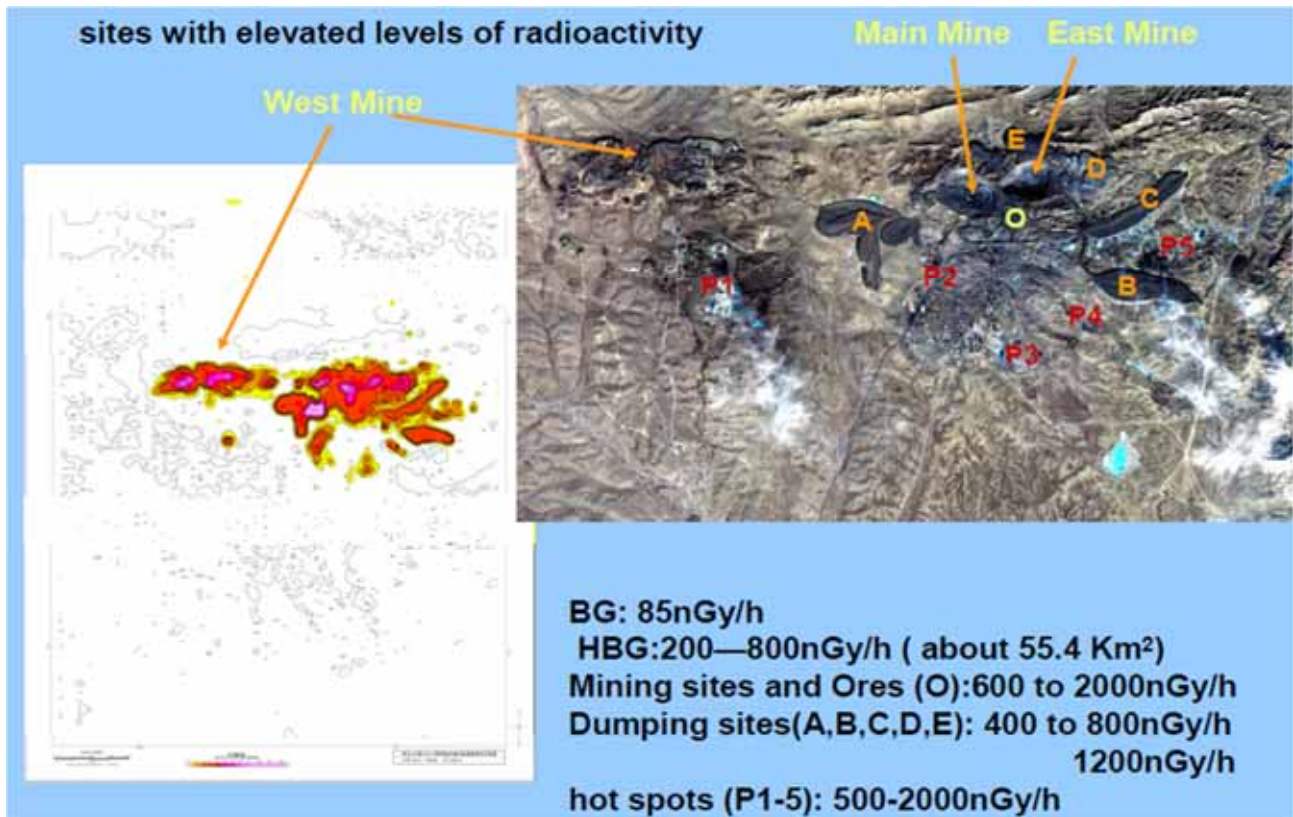

**Figure 60 Rare earth extraction in Bayan-Obo (China): Sites with elevated levels of radioactivity [Qifan 2010]**

**REE from China, assessment:**

REE extraction and processing in China is still characterised by considerable environmental impacts. This severe environmental impact due to toxic and radioactive substances also leads to massive health hazards for employees and the local population. Although the Chinese central government is trying to reduce the negative impacts of the rare earth element industry, no decisive breakthroughs have been made so far.

*Disclaimer: an assessment is always dependant on the individual situation on the ground at any site. The evaluation presented here is based on a generalized summary of known common issues for a given raw material. No conclusion regarding specific production sites can be drawn from this assessment.*

Environment: ● Social: ● Overall: ●



## 5 Summary and conclusions

Though exact quantification and weighting is difficult, it was shown that resources required for both ICE and BEV cause negative environmental and social impacts.

While the negative impacts of crude oil extraction already exist on a large scale today and have not been tackled yet, the negative impacts from metal extraction will only be scaled up in the years to come. Nevertheless, some metals like copper and nickel are already extracted on a larger scale today for many other applications than EVs. Both metal mining and fossil fuel extraction impacts must be tackled to mitigate negative social and environmental effects of motorised road transport.

Section 4 refers to characteristics and hotspots of the social and environmental impacts for the extraction of each priority raw material. In this section, the general assessments from section 4 are summarised and then evaluated. The following Table 5 repeats from section 4 the ranking scheme and the corresponding colour code to summarise the assessments of raw materials: the rating scale ranges from low (green) to high (red) negative environmental and social impacts of resource extraction.

**Table 5 Ranking scheme (stoplight colour code) for overall assessment of raw materials**

low	Low/medium	medium	Medium/high	high
				

Table 6 below provides an overview of the assessments made in the previous chapter. The disclaimer below applies to all these ratings:

Disclaimer: an assessment is always dependant on the individual situation on the ground at any site. The evaluation presented here is based on a generalized summary of known common issues for a given raw material. No conclusion regarding specific sites can be drawn from this assessment.

**Table 6 Overview assessment of social and environmental impacts of resource demand**

Raw material	Main supply countries	Assessment (stoplight coding)
Crude oil	Russia	
Crude oil	Norway	
Crude oil	Libya	
Crude oil	Nigeria	
Crude oil	USA	
PGM	Russia / South Africa	
Lithium	Australia / Latin America	
Graphite	China	
Cobalt	DRC	
Nickel	Global mix	
REE	China	

\* The assessment characterises the individual country or group of countries named, and does not necessarily represent an assessment of the raw material in general

From Table 6 it becomes evident that there are considerable negative environmental and social impacts associated with ICE (see results for crude oil) and PHEV/BEV (see results for metals) alike.



In this study, crude oil production in Russia, Norway, Libya, Nigeria and the USA was examined in more detail, as these countries together cover a large share of Germany's crude oil supply (67.9 % of German crude oil imports 2018: see section 4). Russia is of paramount importance for Germany's supply, as it makes the highest contribution to Germany's crude oil supply (36.6 % in 2018). According to the general assessment, apart from Norway (11.8 % share of Germany's crude oil supply in 2018), the assessment for all other states is at best medium (USA) or worse (Russia, Libya, Nigeria). In other words, significantly more than 50 % of Germany's crude oil supply is provided by countries where crude oil extraction is often associated with serious or even catastrophic (Nigeria) environmental pollution and/or negative social consequences. Regarding the assessment for environmental aspects, it must be noted that only the extraction of crude oil is included in the assessment. The combustion of crude oil products petrol and diesel in internal combustion engines and the associated greenhouse gas emissions, pollution from fine dust and other negative impacts resulting from combustion are not included in this assessment.

For the key raw materials for traction batteries, on the other hand, there are also general estimates for raw material extraction to have medium (for lithium and nickel) to high (for graphite and cobalt) negative social and environmental impacts. This also applies to the extraction of PGM raw materials (necessary for the catalytic converters in combustion vehicles) and for the extraction of rare earth elements (important for electric motors and wind power generators, but also for car exhaust catalytic converters).

In summary, the following main conclusions can be drawn from the results of this study:

- **In 2035, annual crude oil demand can be cut by 56 % of the demand in 2020:** The results of the EV Scenario – where 100 % of new cars are BEVs in 2035 – show that an ambitious market ramp-up of electric vehicles in the German passenger car sector by 2035 can cut the annual crude oil demand by 56 % in the German passenger car sector by 2035 compared to 2020. This will result in a significant reduction of the necessary oil processing infrastructure in the medium term. These crude oil savings are much higher than the fossil energy sources needed to cover the additional electricity demand for electric vehicles. Thus, an ambitious market ramp-up of electromobility is associated with very high net savings of fossil energy sources (in tonnes).
- **Reduced oil demand implies reduced impacts from oil sourcing, as Germany imports most of its crude oil from countries with weak environmental and social standards:** The majority of crude oil imported to Germany (and to the EU) currently comes from producing countries with mediocre to poor or very poor standards for reducing environmental impacts or negative social effects from crude oil production. Moreover, criteria for crude oil procurement for Germany according to social and environmental aspects are still missing, despite the high relevance of crude oil in road transport over the last decades. In contrast to metals, there is still a lack of critical and systematic debate on crude oil.
- **Raw materials for batteries and electric motors are dominant in the EV Scenario:** The EV Scenario, on the other hand, results in a growing demand for materials such as copper, nickel, cobalt, lithium, and rare earth elements. These materials are mainly needed for batteries and electric motors, while raw material requirements for the expansion of wind power and photovoltaic (PV) are significantly lower.
- **Higher secondary metal content and stricter environmental and social standards in primary raw material extraction are key to reducing environmental impacts:** Several metals for core components of electro-mobility are currently extracted in countries with very poor environmental and social standards. However, there is potential for reducing the negative environmental and social impacts of raw material extraction to meet the future metal demand. Ambitious recycling

and higher secondary metal shares as well as strict governmental regulations and company policies for the supply chain of key metals from primary supply are important building blocks for ensuring reduced environmental impacts.

- **Peak in primary metal demand by 2035 at the latest, under the EV Scenario:** Since in the EV Scenario 100 % of new passenger vehicles in Germany would be BEVs in 2035 and secondary metal quotas should rise continuously over the next years, the peak primary metal consumption for the passenger car sector should already be reached around 2035. The resource demand for fossil fuels will already have declined sharply by 2035 and will tend towards zero in the years thereafter until 2050 at the latest.
- **Zero PGM demand for automotive catalysts in 2035:** Consumption of platinum group metals (PGMs) for automotive catalytic converters under the EV Scenario will also fall sharply – to zero in 2035. As PGMs from automotive catalysts represent an important secondary metal source through recycling, the recovered PGMs can be used to supply material for future applications such as fuel cells and the hydrogen infrastructure in the medium term.
- **Fossil fuels are wasted after use, but metals can be recycled:** In 2035, when comparing the EV Scenario with the Combustion Scenario, around 6.7 million tonnes of fossil fuels (petrol, diesel, lignite, etc.) are saved, while an additional amount of almost 185 000 tonnes of metals are needed in 2035. The additional metals needed in the EV Scenario can be kept in a circular economy through recycling. Fossil fuels, on the other hand, are lost after combustion and pose an economic burden (e.g. through CO<sub>2</sub> pricing), while metals recycling can stimulate economic growth.

## 6 Recommendations

The following recommendations can be derived from the results of the study:

### **Mandatory supply-chain due diligence for key battery materials**

The debate regarding mandatory supply-chain due diligence for all materials is gaining pace on the EU level through manifold regulations. Among others, the recently published proposal for an update of the Battery Regulation addresses mandatory supply-chain due diligence, referring to the OECD Due Diligence Guidance<sup>48</sup>. These developments are of crucial importance to establishing a level playing field.

Currently responsible companies are facing economic disadvantages by applying high standards, while companies performing badly are at a competitive advantage due to lower operation costs. In the context of the rapid uptake of EVs, it is clear that, in the mid-term, the largest share of supply will have to be covered by primary sources. Recycling clearly is of central importance but will not be able to fulfil significant portions of demand in the short-term (also see other recommendations). EVs are also promoted as the environmentally ‘cleaner’ option for individual mobility. Considering this argument, it is even more important to make sure that the raw materials required to make these vehicles are produced in a responsible and sustainable manner.

Mandatory supply-chain due diligence could ensure a level playing field and the possibility for security of investment by promoting cleaner and better extraction. Accordingly, it is recommended that the German Federal Government support the EU Commission's endeavours regarding supply-chain due diligence. This also applies to other key raw materials such as rare earth elements for electric motors and wind turbines.

---

<sup>48</sup> OECD Due Diligence Guidance for Responsible Supply Chains of Minerals from Conflict-Affected and High-Risk Areas

### **Demand ambitious recycling targets for key materials for batteries**

Recycling of strategic metals, such as cobalt, lithium, copper and nickel from lithium-ion batteries, is critical to the sustainable expansion of electro-mobility in the EU and a step towards building a significant domestic source of raw materials ('mine above ground'). The German Federal Government should therefore support the EU Commission's proposal on the EU Batteries Regulation – i.e. the introduction of ambitious material-specific recovery quotas for copper, cobalt, nickel and lithium; the proposals on future recycled content; as well as the other proposed measures – which together represent a milestone for the Circular Economy in Europe.

### **Entering a recycling economy also for rare earth elements in Europe**

Furthermore, it is recommended that the German Federal Government strongly support and continue the existing German and European research and development activities to establish a European cycle for rare earth elements from spent neodymium-iron-boron magnets (from EV motors and wind power generators). This would support the goal of reducing Germany's and the EU's dependence on non-European supplier countries with great market dominance.

### **Accelerating the expansion of renewable energies for the power sector**

The scenario results from this study indicate that the additional demand for key materials to electrify the passenger vehicle fleet is primarily due to the production of the vehicle itself and not primarily due to the upstream electricity needs (i.e. the expansion of wind power and PV infrastructure). Electric vehicles are highly energy efficient and the additional electricity needs are limited, in particular when compared to power-to-liquid options. The further expansion of wind power and photovoltaic (PV) clearly brings resource advantages (and of course reduces greenhouse gas emissions) by further minimising the share of fossil fuels used in Germany's electricity mix. The German Federal Government is therefore recommended to accelerate expanding wind power (onshore and offshore) and PV infrastructure.

### **Responsible sourcing criteria for remaining crude oil production**

The argument for electrifying the German passenger vehicle fleet can easily be based on a resource perspective, in particular when considering the negative impacts of oil sourcing. Even if fossil fuel use may be on its way out in Germany, the question remains why the issues and impacts of oil sourcing have gained little attention for decades. It is recommended that the German Federal Government develop and adopt criteria for crude oil extraction that include strict requirements to minimise the negative environmental and social impacts as much as possible.

## 7 References

- [Adesoji 2019]: Adesoji, B. S. (2019): Top trading partners for Nigeria's exports and imports in 2019. <https://nairametrics.com/2019/08/12/top-trading-partners-for-nigerias-exports-and-imports-in-2019/> (26.11.2020)
- [Adomaitis 2020]: Adomaitis, N. (2020): Norway proposes new oil exploration blocks, but none in Barents Sea. <https://www.reuters.com/article/us-norway-oil/norway-proposes-new-oil-exploration-blocks-but-none-in-barents-sea-idUSKBN21H168> (20.11.2020)
- [AG Energiebilanzen 2020]: AG Energiebilanzen (2020): Bilanzen 1990-2018. <https://ag-energie-bilanzen.de/7-0-Bilanzen-1990-2017.html> (22.01.2021)
- [Agusdinata et al. 2018]: Agusdinata, D. B; Liu, W.; Eakin, H.; Romero, H. (2018): Socio-environmental impacts of lithium mineral extraction: towards a research agenda. In: Environmental Research Letters, Volume 13, Number 12. <https://doi.org/10.1088/1748-9326/aae9b1> (01.02.2021).
- [Al Barazi et al. 2017] Al Barazi, S.; Näher, U.; Vetter, S.; Schütte, P.; Liedtke, M.; Baier, M.; Franken, G. (2017): Cobalt from the DR Congo – Potential, Risks and Significance for the Global Cobalt Market. [https://www.bgr.bund.de/DE/Gemeinsames/Produkte/Downloads/Commodity\\_Top\\_News/Rohstoffwirtschaft/53\\_kobalt-aus-der-dr-kongo\\_en.pdf?blob=publicationFile&v=6](https://www.bgr.bund.de/DE/Gemeinsames/Produkte/Downloads/Commodity_Top_News/Rohstoffwirtschaft/53_kobalt-aus-der-dr-kongo_en.pdf?blob=publicationFile&v=6) (08.01.2021)
- [Albeck-Ripka 2020]: Albeck-Ripka, L. (2020): Mining Firm Plans to Destroy Indigenous Australian Sites, Despite Outcry. The New York Times. <https://www.nytimes.com/2020/06/11/world/australia/indigenous-caves-BHP-mining.html> (09.01.2021)
- [Albemarle 2018]: Albemarle (2018): Albemarle and Western Australia. [https://www.albemarle.com/storage/wysiwyg/alb\\_kemerton\\_literature\\_051618\\_a4\\_fnl.pdf](https://www.albemarle.com/storage/wysiwyg/alb_kemerton_literature_051618_a4_fnl.pdf) (27.07.2020)
- [Aljazeera 2020 A]: Aljazeera (2020): Libya's NOC accuses UAE of being behind oil blockade. <https://www.aljazeera.com/economy/2020/07/12/libyas-noc-accuses-uae-of-being-behind-oil-blockade/> (25.11.2020)
- [Aljazeera 2020 B]: Aljazeera (2020): Forty percent of Nigerians live below the poverty line: Report. <https://www.aljazeera.com/economy/2020/5/4/forty-percent-of-nigerians-live-below-the-poverty-line-report> (25.11.2020)
- [Amec Foster Wheeler 2017]: Amec Foster Wheeler (2017): ReCAP Project - Evaluating the Cost of Retrofitting CO<sub>2</sub> Capture in an Integrated Oil Refinery: Description of Reference Plants. <https://www.sintef.no/en/projects/2014/recap/> (21.01.2021)
- [Amnesty International 2020 A]: Amnesty International (2020): Nigeria: 2020 could be Shell's year of reckoning. <https://www.amnesty.org/en/latest/news/2020/02/nigeria-2020-could-be-shell-year-of-reckoning> (25.11.2020)
- [Amnesty International 2020 B]: Amnesty International (2020): No clean up, no justice: Shell's oil pollution in the Niger Delta. <https://www.amnesty.org/en/latest/news/2020/06/no-clean-up-no-justice-shell-oil-pollution-in-the-niger-delta/> (26.11.2020)
- [AP 2018]: AP News, Joling, D. (2018): Arctic offshore production wells approved off Alaska's coast. <https://apnews.com/article/73e0b2c8f8854c5482f34af9f889b3dc> (12.01.2021)

- [Argonne 2020] Argonne National Laboratory (2020): BatPaC Model Software 4 <https://www.anl.gov/cse/batpac-model-software> (14.09.2020)
- [Atradius 2020]: Atradius Group (2020): Country Report Russia 2020. <https://group.atradius.com/publications/country-report-eastern-europe-russia-2020.html> (30.11.2020)
- [Austin 2019]: Austin, R. (2019): Ogoni widows testify at The Hague over Shell's alleged complicity in killings. <https://www.theguardian.com/global-development/2019/feb/12/ogoni-widows-testify-the-hague-shell-alleged-complicity-killings> (25.11.2020)
- [Austrade 2020]: Australian Trade and Investment Commission (Austrade) (2020): Social Licence to Operate in LATAM's mining sector. [https://www.austrade.gov.au/news/insights/social-licence-to-operate-in-latam-s-mining-sector#\\_ftn1](https://www.austrade.gov.au/news/insights/social-licence-to-operate-in-latam-s-mining-sector#_ftn1) (09.01.2021)
- [Azevedo et al. 2020] Azevedo, M.; Goffaux, N.; Hoffman, K. (2020) How clean can the nickel industry become? Global demand for Class 1 nickel could skyrocket, especially for use in electric vehicles. Can the industry meet these needs—and sustainability goals?. McKinsey & Company. <https://www.mckinsey.com/~media/McKinsey/Industries/Metals%20and%20Mining/Our%20Insights/How%20clean%20can%20the%20nickel%20industry%20become/How-clean-can-the-nickel-industry-become.pdf> (18.01.2021)
- [Babatunde 2020]: Babatunde, A. O. (2020): How oil and water create a complex conflict in the Niger Delta. <https://theconversation.com/how-oil-and-water-create-a-complex-conflict-in-the-niger-delta-135105> (26.11.2020)
- [BAFA 2020]: Bundesamt für Wirtschaft und Ausfuhrkontrolle (2020): Rohöl INFO [https://www.bafa.de/SiteGlobals/Forms/Suche/Nachrichtenarchiv/Nachrichtenarchiv\\_Formular.html?submit=Senden&resultsPerPage=20&templateQueryString=RohölINFO&sortOrder=dateOfIssue+dt+desc](https://www.bafa.de/SiteGlobals/Forms/Suche/Nachrichtenarchiv/Nachrichtenarchiv_Formular.html?submit=Senden&resultsPerPage=20&templateQueryString=RohölINFO&sortOrder=dateOfIssue+dt+desc) (01.02.2021)
- [Bast et al. 2014]: Bast, U. et al (2014): Recycling of components and strategic metals from electric powertrain, Siemens AG in cooperation with Daimler AG; Umicore AG & Co KG; Vacuumschmelze GmbH; Universität Erlangen-Tübingen; TU Clausthal; Fraunhofer Gesellschaft, Institut für System- und Innovationsforschung (ISI), with funding provided by the German Federal Ministry of Education and Research, Berlin.
- [Bauer 2014]: Bauer, K. (2014): US-Fracking-Boom: Massive Umweltschäden und Kriminalität. <https://www.srf.ch/news/international/us-fracking-boom-massive-umweltschaeden-und-kriminalitaet> (27.11.2020)
- [BBC 2006]: BBC NEWS (2006): Alaska hit by 'massive' oil spill. <http://news.bbc.co.uk/2/hi/americas/4795866.stm> (12.01.2021)
- [BBC 2015] BBC NEWS (2015): US spending bill lifts 40-year ban on crude oil exports. <https://www.bbc.com/news/business-35136831> (27.11.2020)
- [Bengtsson et al. 2018]: Bengtsson, A.; Bengtsson, J., Olsson, C.; Sedin, M.; Jedvert, K.; Theliander, H.; Sjöholm, E. (2018): Improved yield of carbon fibres from cellulose and kraft lignin. In: *Holzforschung* 72 (12), 1007–1016. DOI: 10.1515/hf-2018-0028.
- [Berlund 2020]: Berlund, N. (2020): 'Solid compromise' over the ice edge. <https://www.newsenglish.no/2020/04/24/solid-compromise-over-the-ice-edge/>, Norway settles on its 'ice edge' <https://www.newsenglish.no/2020/06/05/norway-settles-on-its-ice-edge/> (20.11.2020)



- [Berman 2020]: Berman, A. (2020): U.S. Oil Dominance Is Coming To An End. <https://oilprice.com/Energy/Crude-Oil/US-Oil-Dominance-Is-Coming-To-An-End.html> (27.11.2020)
- [BGR 2020]: Federal Institute for Geosciences and Natural Resources, BGR (2020): Kobalt – Informationen zur Nachhaltigkeit. [https://www.deutsche-rohstoffagentur.de/DE/Gemeinsames/Produkte/Downloads/Informationen\\_Nachhaltigkeit/kobalt.pdf?blob=publication-File&v=3](https://www.deutsche-rohstoffagentur.de/DE/Gemeinsames/Produkte/Downloads/Informationen_Nachhaltigkeit/kobalt.pdf?blob=publication-File&v=3) (08.01.2021)
- [BGS 2020]: British Geological Survey, BGS (2020): World Mineral Statistics 2014 – 2018. <https://www.bgs.ac.uk/mineralsuk/statistics/worldArchive.html> (09.01.2021)
- [Bleiwas 2013]: Bleiwas, D.I.; U.S. Geological Survey, USGS (2013): Potential for Recovery of Cerium Contained in Automotive Catalytic Converters. Survey Open-File Report 2013–1037. <http://pubs.usgs.gov/of/2013/1037>. (08.02.2021)
- [BMW 2019]: BMW (2019): Gesamtausgabe der Energiedaten – Datensammlung des BMWi. <https://www.bmw.de/Redaktion/DE/Artikel/Energie/energiedaten-gesamtausgabe.html> (05.06.2020)
- [BP 2019]: BP (2019): Statistical Review of World Energy. <https://www.bp.com/en/global/corporate/energy-economics/statistical-review-of-world-energy.html> (20.11.2020)
- [Buchert et al. 2011]: Buchert, M.; Dittrich, S.; Hacker, F.; Jenseit, W. (2011): Resource efficiency and resource-political aspects of the electro-mobility system. In cooperation with: Umicore AG & Co. KG, Daimler AG, TU Clausthal. [https://www.erneuerbar-mobil.de/sites/default/files/2016-09/Endbericht\\_OPTUM%20Ressourcen\\_final\\_EN.pdf](https://www.erneuerbar-mobil.de/sites/default/files/2016-09/Endbericht_OPTUM%20Ressourcen_final_EN.pdf) (08.02.2021)
- [Buchert et al. 2017]: Buchert, M.; Degreif, S.; Dolega, P. (2017): Ensuring a Sustainable Supply of Raw Materials for Electric Vehicles: A Synthesis Paper on Raw Material Needs for Batteries and Fuel Cells [https://static.agora-verkehrswende.de/fileadmin/Projekte/2017/Nachhaltige\\_Rohstoffversorgung\\_Elektromobilitaet/Agora\\_Verkehrswende\\_Rohstoffstrategien\\_EN\\_WEB.pdf](https://static.agora-verkehrswende.de/fileadmin/Projekte/2017/Nachhaltige_Rohstoffversorgung_Elektromobilitaet/Agora_Verkehrswende_Rohstoffstrategien_EN_WEB.pdf) (18.01.2021)
- [Bundesregierung 2019]: Bundesregierung (2019): Klimaschutzprogramm 2030 der Bundesregierung zur Umsetzung des Klimaschutzplans 2050. <https://www.bundesregierung.de/resource/blob/975226/1679914/e01d6bd855f09bf05cf7498e06d0a3ff/2019-10-09-klima-massnahmen-data.pdf> (08.02.2021)
- [Cairncross 2014]: Cairncross, E. (2014): Health and environmental impacts of platinum mining: Report from South Africa, on behalf of PHM, March 2014, <https://www.thejournalist.org.za/wp-content/uploads/2014/09/Environmental-health-impacts-of-platinum-mining1.pdf> (12.02.2021).
- [CDC 2019]: CDC - Centers for Disease Control and Prevention (2019): Graphite (natural). <https://www.cdc.gov/niosh/npg/npgd0306.html> (07.12.2020)
- [Champion 2019]: Champion, D. (2019): Australian Resource Reviews: Lithium 2018. Geoscience Australia. <http://dx.doi.org/10.11636/9781925848281> (09.01.2021)
- [Chehreh Chelgani et al. 2016]: Chehreh Chelgani, S.; Rudolph, M.; Kratzsch, R.; Sandmann, D.; Gutzmer, J. (2016): A review of graphite beneficiation techniques. *Mineral Processing and Extractive Metallurgy Review* 37. Issue 1, pp. 58-68. <https://doi.org/10.1080/08827508.2015.1115992>.
- [Cheng et al. 2010]: Cheng J., Che L., Current Mining Situation and Potential Development of Rare Earth in China, Baogang Research Institute of Mine, Baotou, Iron & Steel Co., China, *Journal of Chinese Rare Earths*, Vol.31, No.2, PP65-69, 04.2010.



- [Cremonese et al. 2015] Cremonese, L.; Ferrari, M.; Flynn, M. P.; Gusev, A. (2015): Shale Gas and Fracking in Europe. IASS Fact Sheet, 1. [https://www.iass-potsdam.de/sites/default/files/files/shale\\_gas\\_and\\_fracking\\_in\\_europe.pdf](https://www.iass-potsdam.de/sites/default/files/files/shale_gas_and_fracking_in_europe.pdf) (27.11.2020)
- [Crisis Group 2006]: Crisis Group (2006): The Swamps of Insurgency: Nigeria's Delta Unrest. <https://www.crisisgroup.org/africa/west-africa/nigeria/nigerias-endsars-protest-de-escalate-tensions-start-deep-police-reform> (26.11.2020)
- [Darton Commodities 2020]: Darton Commodities (2020): Darton Cobalt Market Research <https://www.dartoncommodities.co.uk/market-research/> (22.06.2020)
- [Daw et al. 2015]: Daw, M. A.; El-Bouzedi, A.; Dau, A. A. (2015): Libyan armed conflict 2011: mortality, injury and population displacement. *African Journal of Emergency Medicine*. Vol 5 (3), pp. 101-107. <https://www.sciencedirect.com/science/article/pii/S2211419X15000348> (23.11.2020)
- [Dehoust et al. 2020] Dehoust, G.; Vogt, R.; von Ackern, P.; Rechlin, A., et al. (2020): Weiterentwicklung von Handlungsoptionen einer ökologischen Rohstoffpolitik ÖkoRess II - Abschlussbericht. UBA Texte 79/2020. [https://www.umweltbundesamt.de/sites/default/files/medien/1410/publikationen/2020-06-17\\_texte\\_79-2020\\_oekoressii\\_abschlussbericht.pdf](https://www.umweltbundesamt.de/sites/default/files/medien/1410/publikationen/2020-06-17_texte_79-2020_oekoressii_abschlussbericht.pdf) (18.01.2021)
- [Dela Cruz & Serapio Jr 2017]: Dela Cruz, E.; Serapio Jr, M. (2017): Philippines to shut half of mines, mostly nickel, in environmental clampdown. Reuters. <https://www.reuters.com/article/us-philippines-mining/philippines-to-shut-half-of-mines-mostly-nickel-in-environmentalclampdown-idUSKBN15H0BQ> (18.01.2021)
- [DeMarban 2021]: DeMarban, A. (2021): Biden blocks drilling in ANWR, among his first acts as president. Anchorage Daily News. <https://www.adn.com/business-economy/energy/2021/01/20/biden-plans-to-block-drilling-in-arctic-refuge-shortly-after-taking-office/> (22.01.2021)
- [DERA 2017]: Deutsche Rohstoffagentur, DERA (2017): DERA Rohstoffinformation Nr. 33: Rohstoffrisikobewertung Lithium. [https://www.deutsche-rohstoffagentur.de/DERA/DE/Downloads/Studie\\_lithium\\_2017.pdf](https://www.deutsche-rohstoffagentur.de/DERA/DE/Downloads/Studie_lithium_2017.pdf) (09.01.2021)
- [DESA 2010]: United Nations Department of Economic and Social Affairs, DESA; United Nations Economic Commission for Latin America and the Caribbean, ECLAC (2010): Senior Expert Group Meeting on Sustainable Development of Lithium Resources in Latin America: Emerging Issues and Opportunities - Conclusions and Recommendations. <https://sustainabledevelopment.un.org/content/documents/Conclusions%20and%20Recommendations%20Lithium%20EGM%20-%20English%20-%20Final.pdf> (09.01.2021)
- [Dessemond et al. 2019]: Dessemond, C.; Lajoie-Leroux, F.; Soucy, G.; Laroche, N.; Magnan, J.F. (2019): Spodumene: The Lithium Market, Resources and Processes. *Minerals* 2019, Vol 9 (6), 334. doi:10.3390/min9060334 (09.01.2021)
- [DGMK 2003]: Deutsche Wissenschaftliche Gesellschaft für Erdöl, Erdgas und Kohle e.V., DGMK Schmiedel, H.-P. (2003): Zusammensetzung von Otto-kraftstoffen aus deutschen Raffinerien -Winterware 2001/2002. Forschungsbericht 502-1. <https://dgmk.de/publikationen/zusammensetzung-von-ottokraftstoffen-aus-deutschen-raffinerien-winterware-2001-2002/> (22.01.2021)

[Dolega et al. 2016]: Dolega, P.; Degreif, S.; Buchert, M.; Schueler, D. (2016): Outlining Environmental Challenges in the Non-Fuel Mining Sector. [https://www.stradeproject.eu/fileadmin/user\\_upload/pdf/PolicyBrief\\_04-2016\\_Sep2016\\_FINAL.pdf](https://www.stradeproject.eu/fileadmin/user_upload/pdf/PolicyBrief_04-2016_Sep2016_FINAL.pdf) (08.02.2021)

[Dolega et al. 2020]: Dolega, P.; Buchert, M.; Betz, J. (2020): Environmental and socio-economic challenges in battery supply chains: graphite and lithium. <https://www.oeko.de/en/publications/p-details/environmental-and-socio-economic-challenges-in-battery-supply-chains-graphite-and-lithium> (09.01.2021)

[Dühnen et al. 2020]: Dühnen, S.; Betz, J.; Kolek, M.; Schmuch, R.; Winter, M.; Placke, T. (2020). Toward Green Battery Cells: Perspective on Materials and Technologies. *Small Methods*, 2000039. <https://doi.org/10.1002/smt.202000039>

[Dunn et al. 2015]: Dunn, J. B.; James, C.; Gaines, L., Gallagher, K.; Dai, Q.; Kelly, J. C. (2015): Material and Energy Flows in the Production of Cathode and Anode Materials for Lithium Ion Batteries. <https://www.osti.gov/biblio/1224963-material-energy-flows-production-cathode-anode-materials-lithium-ion-batteries> (08.02.2021)

[Durrant 2019] Durrant, A. (2019): Indonesian nickel ore ban: who will fill the supply gap?. <https://www.woodmac.com/news/opinion/Indonesian-nickel-ore-ban-who-will-fill-the-supply-gap/> (18.01.2021)

[EC 2020]: European Commission, EC (2020): Proposal for a Regulation Of The European Parliament And Of The Council concerning batteries and waste batteries, repealing Directive 2006/66/EC and amending Regulation (EU) No 2019/1020. COM/2020/798 final. <https://eur-lex.europa.eu/legal-content/EN/TXT/?uri=CELEX:52020PC0798> (08.02.2021)

[EC 2021]: European Commission, EC (2021): Indonesia - Measures Relating to Raw Materials (DS592) Request for the establishment of a panel by the European Union. [https://trade.ec.europa.eu/doclib/docs/2021/january/tradoc\\_159271.pdf](https://trade.ec.europa.eu/doclib/docs/2021/january/tradoc_159271.pdf) (18.01.2021)

[Egba 2020]: Egba, L. (2020): The Empirical Truth about an average Nigerian's price point. <https://nairametrics.com/2020/06/01/the-empirical-truth-about-an-average-nigerians-price-point/> (26.11.2020)

[ENI 2020]: ENI (2020): World Oil Review 2019. <https://www.eni.com/en-IT/global-energy-scenarios/world-oil-review-first-volume.html> (22.01.2021)

[EPI 2020]: Environmental Performance Index, EPI (2020): 2020 EPI Results. <https://epi.yale.edu/epi-results/2020/component/epi> (22.01.2021)

[Evans 2014]: Evans, K. (2014): Lithium. In: Critical Metals Handbook, edited by Gus Gunn. British Geological Survey <https://doi.org/10.1002/9781118755341.ch10> (08.02.2021)

[EVOSTC 2020]: Exxon Valdez Oil Spill Trustee Council (2020): Questions and Answers about the Spill. <https://evostc.state.ak.us/oil-spill-facts/q-and-a/> (12.01.2021)

[Ezama et al. 2018]: Ezama, I.; de los Hoyos, C.; Cortegoso, P.; Braun, T. (2018): Direct Extraction Lithium Processes: The Challenges Of Spent Brine Disposal. [https://dxi97tvbmhbca.cloudfront.net/upload/user/image/Ezama-Hoyos-Cortegoso-Braun-Spent\\_Brine\\_Disposal-TMW\\_Paper20191128190251287.pdf](https://dxi97tvbmhbca.cloudfront.net/upload/user/image/Ezama-Hoyos-Cortegoso-Braun-Spent_Brine_Disposal-TMW_Paper20191128190251287.pdf) (08.02.2021)

- [Falkenberg et al. 2019]: Falkenberg, H.; Krampe, L.; Buchert, M.; Sutter, J.; et al. (2019): Raw material demand in the field of renewable energies. Prognos AG in cooperation with Oeko-Institut. <https://d-eiti.de/wp-content/uploads/2020/02/Raw-material-requirements-in-the-field-of-renewable-energies-executive-summary.pdf> (08.02.2021)
- [Feddern 2001]: Feddern, J. (2001): Riesige Landflächen in Sibirien ölverseucht. <https://www.innovations-report.de/html/berichte/umwelt-naturschutz/bericht-4341.html> (18.11.2020)
- [Figenbaum et al. 2015]: Figenbaum, E.; Assum, T.; Kolbenstvedt, M. (2015): Electromobility in Norway: experiences and opportunities. *Research in Transportation Economics*, 50, pp. 29-38. [https://econpapers.repec.org/article/eeeretrec/v\\_3a50\\_3ay\\_3a2015\\_3ai\\_3ac\\_3ap\\_3a29-38.htm](https://econpapers.repec.org/article/eeeretrec/v_3a50_3ay_3a2015_3ai_3ac_3ap_3a29-38.htm) (20.11.2020)
- [Fioletov et al. 2016]: Fioletov, V.E.; McLinden, C.A.; Krotkov, N.; Li, C.; Joiner, J.; Theys, N.; Carn, S.; Moran, M.D. (2016): A global catalogue of large SO<sub>2</sub> sources and emissions derived from the Ozone Monitoring Instrument. *Atmospheric Chemistry and Physics* 16 (2016), pp. 11479-11519 <https://acp.copernicus.org/articles/16/11497/2016/acp-16-11497-2016.pdf> (18.01.2021).
- [Frankel et al. 2016]: Frankel, T.C.; Whoriskey, P. (2016): Tossed aside in the 'white gold' rush: Indigenous people are left poor as tech world takes lithium from under their feet. [https://www.washingtonpost.com/graphics/business/batteries/tossed-aside-in-the-lithium-rush/?wpisrc=al\\_alert-COMBO-economy%252Bnation](https://www.washingtonpost.com/graphics/business/batteries/tossed-aside-in-the-lithium-rush/?wpisrc=al_alert-COMBO-economy%252Bnation) (09.01.2021)
- [Friends of the Earth Europe 2013]: Friends of the Earth Europe (2013): Lithium Factsheet [https://www.foeeurope.org/sites/default/files/publications/13\\_factsheet-lithium-gb.pdf](https://www.foeeurope.org/sites/default/files/publications/13_factsheet-lithium-gb.pdf) (09.01.2020)
- [Giegrich et al. 2012]: Giegrich, J. et al. (2012): Indicators for the use of raw materials in the context of sustainable development in Germany, ifeu Institute, Umweltbundesamt (ed.), UBA Text 01/2012, Berlin.
- [Global Times 2021]: Rare-earth firms in Ganzhou halt production to rectify environmental issues: <https://www.globaltimes.cn/page/202104/1220587.shtml> (27.05.2021)
- [Gomez-Martin et al. 2018]: Gomez-Martin, A.; Martinez-Fernandez, J.; Ruttert, M.; Heckmann, A.; Winter, M.; Placke, T.; Ramirez-Rico, J. (2018): Iron-Catalyzed Graphitic Carbon Materials from Biomass Resources as Anodes for Lithium-Ion Batteries. *ChemSusChem* 11 (16), pp. 2776–2787. <https://doi.org/10.1002/cssc.201800831>
- [Greenpeace 2019] Greenpeace (2019): Global SO<sub>2</sub> emission hotspot database - Ranking the world's worst sources of SO<sub>2</sub> pollution. [https://storage.googleapis.com/planet4-international-stateless/2019/08/e40af3dd-global-hotspot-and-emission-sources-for-so2\\_16\\_august-2019.pdf](https://storage.googleapis.com/planet4-international-stateless/2019/08/e40af3dd-global-hotspot-and-emission-sources-for-so2_16_august-2019.pdf) (18.01.2021).
- [Griffin 2020]: Griffin, R. (2020): Rising temperatures most likely to hit Russian energy projects furthest North: Trucost. <https://www.spglobal.com/platts/en/market-insights/latest-news/coal/082120-rising-temperatures-most-likely-to-hit-russian-energy-projects-furthest-north-trucost> (20.11.2020)
- [Hagelüken 2005]: Hagelüken, C.; Buchert, M.; Stahl, H. (2005): Stoffströme der Platingruppenmetalle. [https://www.researchgate.net/profile/Christian\\_Hagelueken/publication/270687039\\_Materials\\_Flow\\_of\\_Platinum\\_Group\\_Metals/links/55cf8f7b08ae502646aa455e/Materials-Flow-of-Platinum-Group-Metals.pdf](https://www.researchgate.net/profile/Christian_Hagelueken/publication/270687039_Materials_Flow_of_Platinum_Group_Metals/links/55cf8f7b08ae502646aa455e/Materials-Flow-of-Platinum-Group-Metals.pdf) (09.02.2021)

[Hagelücken 2020]: Hagelücken, C. (2020): Business as unusual – Anforderungen für eine Kreislaufwirtschaft bei Lithium-Ionen Batterien. Presentation C. Hagelücken (Umicore), Berlin Recycling and Secondary Raw Materials Conference, 2. March 2020. <https://muellundabfall.de/ce/business-as-unusual/detail.html> (09.02.2021)

[Haque et al. 2014]: Haque, N.; Hughes, A.; Lim, S.; Vernon, C. (2014): Rare Earth Elements: Overview of Mining, Mineralogy, Uses, Sustainability and Environmental Impact. In *Resources* 3 (4), pp. 614–635. DOI: 10.3390/resources3040614. <https://www.mdpi.com/2079-9276/3/4/614> (15.02.2021).

[Harthan et al. 2020]: Harthan, R. O.; Rappening, J.; Blanck, R.; Böttcher, H.; Bürger, V.; et al. (2020): Treibhausgasminderungswirkung des Klima-schutzprogramms 2030 - Kurzbericht. UBA Texte 33/2020. <https://www.oeko.de/publikationen/p-details/treibhausgasminderungswirkung-des-klimaschutzprogramms-2030> (09.02.2021)

[Heinze et al. 2016]: Heinze, T.; Zemborski, O. (2016): Abgastests unter realen Fahrbedingungen: Autogas-Pkw im Vergleich mit Benzin- und Diesel-Fahrzeugen. Hochschule für Technik und Wirtschaft des Saarlandes. [https://www.dvfg.de/fileadmin/user\\_upload/downloads/studien-gutachten/HTW-Untersuchung\\_PEMS-RDE-WLTC-bei-LPG-Benzin-Diesel-Pkw.pdf](https://www.dvfg.de/fileadmin/user_upload/downloads/studien-gutachten/HTW-Untersuchung_PEMS-RDE-WLTC-bei-LPG-Benzin-Diesel-Pkw.pdf) (09.02.2021)

[Helms et al. 2016]: Helms, H.; Jöhrens, J.; Kämper, C.; Giegrich, J.; Liebich, A.; Vogt, R.; Lambrecht, U. (2016): Further development and in-depth analysis of the life cycle assessment of electric vehicles. Umweltbundesamt (ed.), UBA-Text 27/2016. [https://www.umweltbundesamt.de/sites/default/files/medien/378/publikationen/texte\\_27\\_2016\\_umweltbilanz\\_von\\_elektrofahrzeugen.pdf](https://www.umweltbundesamt.de/sites/default/files/medien/378/publikationen/texte_27_2016_umweltbilanz_von_elektrofahrzeugen.pdf) (09.02.2021)

[Hentschel et al. 2003]: Hentschel, T.; Hruschka, F.; Priester, M. (2003): Artisanal and Small-scale Mining - Challenges and Opportunities. IIED. [https://www.researchgate.net/profile/Felix\\_Hruschka/publication/274138354\\_Artisanal\\_and\\_Small-scale\\_Mining\\_Challenges\\_and\\_Opportunities/links/5516ee5f0cf2d70ee277140e/Artisanal-and-Small-scale-Mining-Challenges-and-Opportunities.pdf](https://www.researchgate.net/profile/Felix_Hruschka/publication/274138354_Artisanal_and_Small-scale_Mining_Challenges_and_Opportunities/links/5516ee5f0cf2d70ee277140e/Artisanal-and-Small-scale-Mining-Challenges-and-Opportunities.pdf) (09.01.2021)

[Holter 2020]: Holter, M. (2020): Norway's Barents Sea ambitions fading as more projects disappoint. <https://www.worldoil.com/news/2020/1/13/norway-s-barents-sea-ambitions-fading-as-more-projects-disappoint> (20.11.2020)

[Holzman 2020]: Holzman, J. (2020): Tesla to meet with Indigenous activists as it plots future supply chain, 30 Sept. 2020, <https://www.spglobal.com/marketintelligence/en/news-insights/latest-news-headlines/tesla-to-meet-with-indigenous-activists-as-it-plots-future-supply-chain-60529019> (12.02.2021).

[Ikenaka et al 2010]: Ikenaka, Y.; Nakayama S.M.M.; Muzandu, K.; Muzandu, K.; Choongo, K.; Teraoka, H.; Mizuno, N.; Ishizuka, M. (2010): Heavy metal contamination of soil and sediment in Zambia. *African Journal of Environmental Science and Technology*; 4 (11). <https://www.ajol.info/index.php/ajest/article/view/71339> (09.02.2021)

[IMOA 2020]: International Molybdenum Assiation, IMOA (2020): Molybdenum market information – Global production and use. <https://www.imoa.info/molybdenum/molybdenum-global-production-use.php> (22.01.2021)

[Industrial Global Union 2018]: Industrial Global Union (2018): Report of the Fact-Finding Mission to the Democratic Republic of Congo: Testimonies of Mineworkers from Kamoto copper -cobalt

- (KCC) and Mutanda copper mine (MUMI). [http://www.industrialunion.org/sites/default/files/uploads/documents/2018/DRC/industrial\\_global\\_unions\\_report\\_of\\_fact-finding\\_mission\\_to\\_drc\\_14-03-2018.pdf](http://www.industrialunion.org/sites/default/files/uploads/documents/2018/DRC/industrial_global_unions_report_of_fact-finding_mission_to_drc_14-03-2018.pdf) (21.01.2021)
- [IV 2019]: Internationales Verkehrswesen, IV (2019): Lithium-Ionen-Batterien: Rohstoffnachfrage und Recyclingpotenzial. Version 23.01.2019. <https://www.internationales-verkehrswesen.de/batterien-rohstoff-und-recycling/> (25.01.2021).
- [Jaffré et al. 2010]: Jaffré, T.; Munzinger, J.; Lowry, P.P. (2010): Threats to the conifer species found on New Caledonia's ultramafic massifs and proposals for urgently needed measures to improve their protection. *Biodiversity Conservation* (2010) 19. pp.1485-1502. <https://doi.org/10.1007/s10531-010-9780-6>
- [Jasmamie 2018]: Jasmamie, C. (2018): Glencore's Congo unit halts cobalt exports from Kamoto mine. <https://www.mining.com/glencores-congo-unit-halts-cobalt-exports-kamoto-mine/> (08.01.2021)
- [JM 2020]: Johnson Matthey, JM (2020): PGM Market Report: May 2020. <https://matthey.com/en/news/2020/pgm-market-report-may-2020> (20.11.2020)
- [Johnson 2020]: Johnson, D. (2020): Libyen-Konferenz in Berlin – Ohne Öl kein Krieg. <https://taz.de/Libyen-Konferenz-in-Berlin/!5655674/> (23.11.2020)
- [JRC 2020]: Carrara, S.; Alves Dias, P.; Plazzotta, B.; Pavel C. (2020): Raw materials demand for wind and solar PV technologies in the transition towards a decarbonised energy system. Joint Research Centre. JRC119941. <http://dx.doi.org/10.2760/160859> (09.02.2021)
- [Kaiman 2014]: Kaiman, J. (2014): Rare earth mining in China: the bleak social and environmental costs, 20 March 2014, <https://www.theguardian.com/sustainable-business/rare-earth-mining-china-social-environmental-costs> (15.02.2021).
- [Karsten et al. 2012]: Karsten, M.; Mackay, L. (2012): Underground environmental challenges in deep platinum mining and some suggested solutions, The Southern African Institute of Mining and Metallurgy, Platinum 2012, <https://www.911metallurgist.com/blog/wp-content/uploads/2016/02/Underground-environmental-challenges-in-deep-platinum-mining-and-some-suggested-solutions.pdf> (12.02.2021).
- [Kathirvel et al. 2018]: Kathirvel, P.; Kwon, S. J.; Lee, H. S.; Karthick, S.; Saraswathy, V. (2018): Graphite Ore Tailings as Partial Replacement of Sand in Concrete. *ACI Materials Journal*, 115 (3), pp. 481-492. <https://www.concrete.org/publications/internationalconcreteabstractsportal.aspx?m=details&ID=51702191> (09.02.2021)
- [KBA 2019]: Federal Motor Transport Authority Kraftfahrtbundesamt, KBA (2019): Verkehr in Kilometern – Inländerfahrleistung. [https://www.kba.de/DE/Statistik/Kraftverkehr/VerkehrKilometer/vk\\_inlaenderfahrleistung/vk\\_inlaenderfahrleistung\\_inhalt.html?nn=2351536](https://www.kba.de/DE/Statistik/Kraftverkehr/VerkehrKilometer/vk_inlaenderfahrleistung/vk_inlaenderfahrleistung_inhalt.html?nn=2351536) (15.01.2021)
- [KBA 2021]: Federal Motor Transport Authority, KBA (2021): Vehicle registrations in December 2020 - Annual balance. Press Release No. 2/2021. [https://www.kba.de/SharedDocs/Pressemitteilungen/DE/2021/pm\\_02\\_2021\\_fahrzeugzulassungen\\_12\\_2020\\_pdf.pdf?blob=publication-File&v=6](https://www.kba.de/SharedDocs/Pressemitteilungen/DE/2021/pm_02_2021_fahrzeugzulassungen_12_2020_pdf.pdf?blob=publication-File&v=6) (09.02.2021)



- [Khrennikova et al. 2020]: Khrennikova, D.; Tanas, O.; Reznik, I. (2020): Russia faces challenges cutting oil output while keeping the industry alive. *World Oil*. <https://www.worldoil.com/news/2020/5/14/russia-faces-challenges-cutting-oil-output-while-keeping-the-industry-alive> (18.11.2020)
- [Kireeva 2019]: Kireeva, A. (2019): For all of Russia's talk about oil drilling in the Arctic, most Arctic oil will likely go untouched. <https://bellona.org/news/arctic/2019-04-for-all-of-russias-talk-about-oil-drilling-in-the-arctic-most-arctic-oil-will-likely-go-untouched> (18.11.2020)
- [Kloff et al. 2005]: Kloff, S.; Wicks, C. (2005): Environmental management of offshore oil development and maritime oil transport. *Fondation internationale du Banc d'Arguin*. <https://www.semanticscholar.org/paper/Environmental-management-of-offshore-oil-and-oil-Kloff-Wicks/7f1aaa60611f745d4f9d79aecd89d45f27d91cd6?p2df> (25.11.2020)
- [Kondratenko 2021]: Tatiana Kondratenko (2021): Why Russia has so many oil leaks <https://www.dw.com/en/russia-oil-spills-far-north/a-56916148> (30.03.2021)
- [Kornfeind 2020]: Kornfeind, H. (2020): FAQ: A Shale New Deal. *Council on foreign relations*. <https://www.cfr.org/blog/faq-shale-new-deal> (27.11.2020)
- [Krauss et al. 2010]: Krauss, C.; Broder, J. M. (2010): BP Says Limits on Drilling Imperil Spill Payouts. [https://www.nytimes.com/2010/09/03/business/03bp.html?\\_r=1&hp](https://www.nytimes.com/2010/09/03/business/03bp.html?_r=1&hp) (27.11.2020)
- [Krivosheev 2021]: Krivosheev, G.: (2021): Norilsk Nickel: 3 Problems That May Restrain Further Growth, 12 Jan. 2021, <https://seekingalpha.com/article/4398624-norilsk-nickel-3-problems-may-restrain-growth>, (12.02.2021).
- [Kromarek et al. 2020] Kromarek, R.; Malisch, R. (2020): Schmierstoff der Weltwirtschaft – "Peak Everything" – Wie Corona das Ende des Ölzeitalters einläutet. <https://www.wallstreet-online.de/nachricht/12546193-schmierstoff-weltwirtschaft-peak-everything-corona-oelzeitalters-einlaeutet/all>
- [Lämmerer et al. 2017]: Lämmerer, W.; Flachberger, H. (2017): Wissenswertes Zur Charakterisierung und Aufbereitung von Rohgraphiten. *BHM Berg- und Hüttenmännische Monatshefte*. Vol. 162 (8). pp. 336–344. <https://doi.org/10.1007/s00501-017-0651-2>
- [Langdon et al. 2016]: Langdon, R. R.; Biggs, H. C.; Rowland, B. (2016): Australian fly-in, fly-out operations: Impacts on communities, safety, workers and their families. *Work*. Vol. 55 (2). pp. 413–427. <https://doi.org/10.3233/wor-162412>
- [Langenheld et al. 2020]: Langenheld, A. et al. (2020): Klimaneutrales Deutschland - In drei Schritten zu null Treibhausgasen bis 2050 über ein Zwischenziel von -65 % im Jahr 2030 als Teil des EU-Green-Deals, Prognos, Öko-Institut, Wuppertal-Institut, Studie im Auftrag von Agora Energiewende, Agora Verkehrswende und Stiftung Klimaneutralität, <https://www.agora-energiewende.de/veroeffentlichungen/klimaneutrales-deutschland/> (05.05.2021)
- [Letterman et al. 1978]: Letterman, R. D.; Mitsch, W. J. (1978): Impact of mine drainage on a mountain stream in Pennsylvania. *Environmental Pollution* Vol. 17 (1), pp. 53–73. [https://doi.org/10.1016/0013-9327\(78\)90055-1](https://doi.org/10.1016/0013-9327(78)90055-1)
- [Lombrana 2018]: Lombrana, L. M. (2018): Bolivia's Almost Impossible Lithium Dream. <https://www.bloomberg.com/news/features/2018-12-03/bolivia-s-almost-impossible-lithium-dream> (13.01.2021)



- [Luhn 2016]: Luhn, A. (2016): "Where the river runs red: can Norilsk, Russia's most polluted city, come clean?". *The Guardian*. 15 September 2016, ISSN 0261-3077, <https://www.theguardian.com/cities/2016/sep/15/norilsk-red-river-russias-most-polluted-city-clean> (12.02.2021).
- [Lutandula & Maloba 2013]: Lutandula, M. S.; Maloba, B. (2013): Recovery of cobalt and copper through reprocessing of tailings from flotation of oxidised ores. *Journal of Environmental Chemical Engineering*. Vol. 1 (4). pp. 1085–1090. <https://doi.org/10.1016/j.jece.2013.08.025>
- [Marques 2020]: Marques, C.F. (2020): Mining for the Green Economy Is Still Dirty Work, 3. Dec. 2020, <https://www.bloomberg.com/opinion/articles/2020-12-03/cleaning-up-metals-mining-is-a-huge-task-norilsk-nickel-has-a-plan> (12.02.2020).
- [McClenaghan 2012]: McClenaghan.M. (2012). "South African massacre was the tip of an iceberg" *The Bureau of Investigative Journalism*, 18 October 2012, <https://www.thebureauinvestigates.com/opinion/2012-10-18/south-african-massacre-was-the-tip-of-an-iceberg> (12.02.2021).
- [Mudd 2009]: Mudd, G. M. (2009): Nickel Sulfide Versus Laterite : The Hard Sustainability Challenge Remains. *Proc. 48th Annual Conference of Metallurgists*. Canadian Metallurgical Society. Sudbury, Canada. August 2009. [https://www.researchgate.net/publication/228470255\\_Nickel\\_Sulfide\\_Versus\\_Laterite\\_The\\_Hard\\_Sustainability\\_Challenge\\_Remains](https://www.researchgate.net/publication/228470255_Nickel_Sulfide_Versus_Laterite_The_Hard_Sustainability_Challenge_Remains) (09.02.2021)
- [Mudd 2010]: Mudd, G. (2010): Global trends and environmental issues in nickel mining: Sulfides versus laterites. *Ore Geology Review*. Vol. 38 (1-2). pp. 9-26. <https://doi.org/10.1016/j.oregeorev.2010.05.003>
- [NAIF 2018]: Northern Australian Infrastructure Facility, NAIF (2018): Pilbara Minerals Limited - Upgrade Pippingarra Road, a 70km public road to access the Pilgangoora lithium-tantalum mine (Investment Decision August 2018). <https://naif.gov.au/case-studies/pilbara-minerals-investment-decision/> (15.07.2020)
- [Nairametrics 2020]: Nairametrics (2020): How Nigeria recorded its highest non-oil exports ever in 2019. <https://nairametrics.com/2020/04/10/revenue-from-nigerias-non-oil-export-was-highest-in-2019/> (25.11.2020)
- [NEWSru 2012]: NEWSru (2012): В Ханты-Мансийском автономном округе добыта 10-миллиардная тонна нефти. <https://www.newsru.com/finance/22feb2012/ugra.html> (30.11.2020)
- [Nilsen 2020]: Nilsen, T. (2020): Norway proposes to open 125 new oil exploration blocks in the Barents Sea. <https://thebarentsobserver.com/en/industry-and-energy/2020/06/norway-proposes-open-125-new-oil-exploration-blocks-barents-sea> (20.11.2020)
- [Norwegian Petroleum Directorate 2020]: Norwegian Petroleum Directorate (2020): Oil and gas exports. <https://www.norskpetroleum.no/en/production-and-exports/exports-of-oil-and-gas/#> (20.11.2020)
- [NEP 2019]: Netzentwicklungsplan (2019): Netzentwicklungsplan Strom 2030. Version 2019, zweiter Entwurf. <https://www.netzentwicklungsplan.de/de/netzentwicklungsplaene/netzentwicklungsplan-2030-2019> (09.02.2021).
- [Norilsk Nickel 2020]: Mining and Metallurgical Company Norilsk Nickel, consolidated financial statements for the years ended 31 December 2019, 2018 and 2017, Nornickel. 26 February 2020,

[https://www.nornickel.com/upload/iblock/745/12M\\_2019\\_IFRS\\_Consolidation\\_Eng\\_USD.pdf](https://www.nornickel.com/upload/iblock/745/12M_2019_IFRS_Consolidation_Eng_USD.pdf)  
(12.02.2021).

[Nuss et al. 2014]: Nuss P, Eckelman MJ (2014) Life Cycle Assessment of Metals: A Scientific Synthesis. PLoS ONE 9(7): e101298. doi:10.1371/journal.pone.0101298, <https://journals.plos.org/plosone/article?id=10.1371/journal.pone.0101298> (12.01.2021).

[Nwannekanm 2019]: Nwannekanm, B. (2019): Ogoni clean up exercise lacks transparency, accountability. <https://guardian.ng/property/ogoni-clean-up-exercise-lacks-transparency-accountability/> (26.11.2020)

[OEC 2020]: Observatory of Economic Complexity, OEC (2020): Libya. <https://oec.world/en/profile/country/lby/> (23.11.2020)

[OE Digital 2020]: Digital Offshore Engineer, OE; McWilliams, G. (2020): U.S. Gulf of Mexico: 33% of Offshore Oil Output Shut Ahead of Storm. <https://www.oedigital.com/news/479115-u-s-gulf-of-mexico-33-of-offshore-oil-output-shut-ahead-of-storm> (12.01.2021)

[Offshore Energy 2018]: Offshore Energy (2018): U.S. approves first offshore oil platform in Alaska's federal waters. <https://www.offshore-energy.biz/u-s-approves-first-offshore-oil-platform-in-alaskas-federal-waters/> (12.01.2021)

[Offshore Energy 2019]: Offshore Energy (2019): Eni takes over Oooguruk oil field offshore Alaska. <https://www.offshore-energy.biz/eni-takes-over-oooguruk-oil-field-offshore-alaska/> (12.01.2021)

[Offshore Technology 2019]: Offshore Technology; Evans, S. (2019): The future of Alaska's oil. <https://www.offshore-technology.com/features/the-future-of-alaskas-oil/> (12.01.2021)

[Offshore Technology 2020]: Offshore Technology (2020): Johan Castberg Field Development Project, Barents Sea. <https://www.offshore-technology.com/projects/skrugard-field-development-project-norway/> (20.11.2020)

[Oilfield Technology 2020]: Oilfield Technology; Woodroof, N. (2020): Trump administration opens Arctic Alaskan areas to oil development. <https://www.oilfieldtechnology.com/exploration/26062020/trump-administration-opens-arctic-alaskan-areas-to-oil-development/> (12.01.2021)

[Osagie 2013]: Osagie, E. G. (2013): An Overview of the Nigerian Oil and Gas Industry Local Content Initiative. <https://www.energymixreport.com/an-overview-of-the-nigerian-oil-and-gas-industry-local-content-initiative/> (26.11.2020)

[Osborn et al. 2020]: Osborn, A.; Balmforth, T. (2020): Russia's Nornickel fights cover-up accusations over Arctic oil spill. <https://www.reuters.com/article/us-russia-pollution-insight/russias-nornickel-fights-cover-up-accusations-over-arctic-oil-spill-idUSKBN24B0QH> (20.11.2020)

[Paraskova 2019]: Paraskova, T. (2019): Nigeria Shuts In More Oil After Protests In Niger Delta. <https://oilprice.com/Energy/Crude-Oil/Nigeria-Shuts-In-More-Oil-After-Protests-In-Niger-Delta.html> (26.11.2020)

[Perner et al. 2018]: Perner, J.; Unteutsch, M.; Lövenich, A. (2018): Die zukünftigen Kosten strombasierter synthetischer Brennstoffe, Agora Verkehrswende (Hrsg.). [https://www.agora-verkehrswende.de/fileadmin/Projekte/2017/Die\\_Kosten\\_synthetischer\\_Brenn- und\\_Kraftstoffe\\_bis\\_2050/Agora\\_SynCost-Studie\\_WEB.pdf](https://www.agora-verkehrswende.de/fileadmin/Projekte/2017/Die_Kosten_synthetischer_Brenn- und_Kraftstoffe_bis_2050/Agora_SynCost-Studie_WEB.pdf) (05.05.2021)

- [Picard et al. 2006]: Picard, D.; Ahmed, A. F. M.; Gjerald, E.; Nordrum, S.; Yesserkepova, I. (2006): Fugitive Emissions – Oil and Gas. [https://www.ipcc-nggip.iges.or.jp/public/2006gl/pdf/2\\_Volume2/V2\\_4\\_Ch4\\_Fugitive\\_Emissions.pdf](https://www.ipcc-nggip.iges.or.jp/public/2006gl/pdf/2_Volume2/V2_4_Ch4_Fugitive_Emissions.pdf) (20.11.2020)
- [Pieprzyk et al. 2016]: Pieprzyk, B; Rojas Hilje, P. (2016): Flaring und Venting von Erdölbegleitgas. [http://biokraftstoffverband.de/index.php/stellungnahmen-und-studien/'A/0.html?file=tl\\_files/download/Stellungnahmen\\_und\\_Studien/08-01-16%20Flaring%20und%20Venting%20von%20Erdoelbegleitgas%20era%20Pieprzyk-1.pdf](http://biokraftstoffverband.de/index.php/stellungnahmen-und-studien/'A/0.html?file=tl_files/download/Stellungnahmen_und_Studien/08-01-16%20Flaring%20und%20Venting%20von%20Erdoelbegleitgas%20era%20Pieprzyk-1.pdf) (20.11.2020)
- [Pillot 2019]: Pillot, C. (2019). The rechargeable battery market and main trends 2018-2030. *Proceedings of the Advanced Automotive Battery Conference, San Diego*. <https://nio-bium.tech/en/pages/gateway-pages/pdf/technical-briefings/the-rechargeable-battery-market-and-main-trends-2018-2030> (09.02.2021)
- [Pirog 2007]: Pirog, R. (2007): CRS Report for Congress – Russian Oil and Gas Challenges. <https://fas.org/sqp/crs/row/RL33212.pdf> (18.11.2020)
- [Plötz et al. 2020]: Plötz, P.; Moll, C.; Bieker, G.; Mock, P.; Li, Y. (2020): Real-World Usage Of Plug-In Hybrid Electric Vehicles fuel Consumption, Electric Driving, And CO<sub>2</sub> Emissions. [https://www.isi.fraunhofer.de/content/dam/isi/dokumente/cce/2020/PHEV\\_ICCT\\_FraunhoferISI\\_white\\_paper.pdf](https://www.isi.fraunhofer.de/content/dam/isi/dokumente/cce/2020/PHEV_ICCT_FraunhoferISI_white_paper.pdf) (10.02.2021)
- [Ponomarewa 2012]: Ponomarewa, J. (2012): Lecks an russischen Erdölleitungen. [https://de.rbth.com/articles/2012/08/30/lecks\\_an\\_russischen\\_erdoelleitungen\\_15049](https://de.rbth.com/articles/2012/08/30/lecks_an_russischen_erdoelleitungen_15049) (18.11.2020)
- [Poussenkova 2018]: Poussenkova, N.; Overland, I. (2018): Russia: Public debate and the petroleum sector. *Public Brainpower*. pp. 261-289. [https://doi.org/10.1007/978-3-319-60627-9\\_15](https://doi.org/10.1007/978-3-319-60627-9_15)
- [Prussi et al. 2020]: Prussi, M.; Yugo, M.; De Prada, L.; Padella, M.; Edwards, R.; Lonza, L. (2020): JEC Well-to-Tank report v5. JRC Science for policy report. Joint Research Centre. JRC119036. <http://dx.doi.org/10.2760/959137> (21.01.2021)
- [Pure Energy Minerals 2017]: Pure Energy Minerals (2017): 21st Century Lithium: Benchmark Q2 Review 2017. <http://pureenergyminerals.com/wp-content/uploads/2017/07/p27-33.pdf> (09.01.2021)
- [Puschkarsky et al. 2014]: Puschkarsky, T.; Kirchgatter, J.; Ratzlaff, S.; Korolczuk, A.; Frohnhaus, J.; Drbohlav, A. (2014): Profit um jeden Preis. <https://www.wwf.de/fileadmin/fm-wwf/Publikationen-PDF/WWF-Hintergrundinformation-Profit-um-jeden-Preis-OEifoerderung-in-Naturregionen.pdf> (25.11.2020)
- [Qifan, 2010]: Qifan, W.: Enhanced Natural Radiation Exposure in China, Presented on EMRAS II WG2 4th Meeting. EMRAS (Environmental Modelling for Radiation Safety) of the IAEA (International Atomic Energy Agency), 29 Sept. 2010, <https://www-ns.iaea.org/downloads/rw/projects/emras/emras-two/first-technical-meeting/fourth-working-group-meeting/working-group-presentations/workgroup2-presentations/minutes-4th-wg2-mtg.pdf> (15.02.2021).
- [Ramaphosa 2021]: Ramaphosa, C. (2021): We have sought to resolve miners concerns, Opening address by President Cyril Ramaphosa at the virtual Investing in African Mining Indaba 2021, 3 Feb. 2021, <https://www.politicsweb.co.za/archive/sa-mining-has-once-again-shown-tremendous-resilien> (12.02.2021).
- [Raputa e al. 2019]. Raputa, V.F.; Simonenkov, D.V.; Belan, B.D.; Yaroslavtseva, T.V. (2019). "Estimation of SO<sub>2</sub> Emission into the Air of the Norilsk Industrial Region". *Atmospheric and Oceanic*

Optics. 32 (6): 650–654, 19 March 2019. doi:10.1134/S1024856019060125, <https://link.springer.com/article/10.1134/S1024856019060125> (12.02.2021).

[Reuters 2020 A]: Reuters (2020): Energy firms prepare to resume U.S. Gulf of Mexico output after storm passes. <https://www.reuters.com/article/us-storm-cristobal-oil/energy-firms-prepare-to-resume-u-s-gulf-of-mexico-output-after-storm-passes-idUSKBN23F1X1> (12.01.2021)

[Reuters 2020 B]: Reuters (2020): Clean-up crews tackle Valdez Marine Terminal oil spill in Alaska. <https://www.reuters.com/article/us-usa-alaska-spill/clean-up-crews-tackle-valdez-marine-terminal-oil-spill-in-alaska-idUSKCN21X3C5> (12.01.2021)

[Ridderhof 2013]: Ridderhof, R. (2013): Shell and Ogoni People: (s)oil pollution in the Niger Delta. <https://www.peacepalacelibrary.nl/2013/02/shell-and-ogoni-people-soil-pollution-in-the-niger-delta/> (25.11.2020)

[Robinson et al. 2017]: Robinson, G. R. Jr.; Hammarstrom, J. M.; Olson, D. W. (2017): Graphite. *Critical Mineral Resources of the United States - Economic and Environmental Geology and Prospects for Future Supply*. U.S. Geological Survey. <https://pubs.er.usgs.gov/publication/pp1802J> , (07.12.2020)

[Rodrigo et al. 2009]: Rodrigo, A.; Vincent, J. (2009): Estimating the opportunity cost of lithium extraction in the Salar de Uyuni, Bolivia. [https://dukespace.lib.duke.edu/dspace/bitstream/handle/10161/1554/Aguilar,%20Rodrigo MP 2009.pdf](https://dukespace.lib.duke.edu/dspace/bitstream/handle/10161/1554/Aguilar,%20Rodrigo%20MP%202009.pdf) (09.01.2020)

[Roskill 2019]: Roskill (2019): Graphite market continuously shaped by pollution controls. <https://www.globenewswire.com/news-release/2019/06/12/1867350/0/en/Roskill-Graphite-market-continuously-shaped-by-pollution-controls.html> (07.12.2020)

[Rost 2014]: Rost, N. (2014): Fracking zwingt USA zur Lockerung des Öl-Exportverbots. Peak Oil. <https://www.peak-oil.com/2014/06/fracking-zwingt-usa-zur-lockerung-des-oel-exportverbots/> (09.02.2021)

[Saleem 2014]: Saalem, A., H. (2014): Social and Environmental Impact of the Rare Earth Industries, Resources 2014, 3, 123-134; doi:10.3390/resources3010123, March 2014, <https://www.mdpi.com/2079-9276/3/1/123> (15.02.2014).

[S&P Global 2020 A]: S&P Global Platts (2020): Insight from Moscow: Russian Arctic oil and gas development continues despite climate concerns. [https://plattslive.com/media\\_topics/insight-from-moscow-russian-arctic-oil-and-gas-development-continues-despite-climate-concerns/](https://plattslive.com/media_topics/insight-from-moscow-russian-arctic-oil-and-gas-development-continues-despite-climate-concerns/) (30.11.2020)

[S&P Global 2020 B]: S&P Global Platts; Blum, J. (2020): Gulf of Mexico oil sector faces pandemic-related risks and hurricanes. <https://www.spglobal.com/platts/en/market-insights/latest-news/oil/052720-gulf-of-mexico-oil-sector-faces-pandemic-related-risks-and-hurricanes> (12.01.2021)

[S&P Global 2020 C]: S&P Global; Sappor, J. (2020): COVID-19 Turns Indonesian Ore Export Ban Into Curse For Nickel Market. <https://www.spglobal.com/marketintelligence/en/news-insights/research/covid19-turns-indonesian-ore-export-ban-into-curse-for-nickel-market> (21.01.2021)

[Schallaböck et al. 2006]: Schallaböck, K. O.; Merten, F.; Fishedick, M.; Ott, H. E.; Brouns, B. Pastowski, A.; Luhmann, H. J., Venjakob, J. (2006): Klimawirksame Emissionen des PKW-Verkehrs und Bewertung von Minderungsstrategien. Wuppertal Institut (ed.). Wuppertal Spezial 34. <https://epub.wupperinst.org/frontdoor/deliver/index/docId/2448/file/WS34.pdf> (09.02.2021)

- [Schmuck et al. 2018]: Schmuck, R.; Wagner, R.; Hörpel, G.; Placke, T.; Winter, M. (2018): Performance and cost of materials for lithium-based rechargeable automotive batteries. *Nature Energy*. Vol. 3 (4), pp. 267–278. <https://doi.org/10.1038/s41560-018-0107-2>
- [Schueler et al. 2011]: Schueler, D.; Degreif, S.; Buchert, M.; Merz, C.; Liu, R. (2011): Study on Rare Earths and Their Recycling - Final Report for The Greens/EFA Group in the European Parliament. Oeko-Institut. [http://www.ressourcenfieber.eu/publications/reports/Rare%20earths%20study\\_Oeko-Institut\\_Jan%202011.pdf](http://www.ressourcenfieber.eu/publications/reports/Rare%20earths%20study_Oeko-Institut_Jan%202011.pdf) (09.02.2021)
- [Schueler et al. 2016]: Schueler, D.; Schleicher, T.; Jenseit, W.; Degreif, S.; Buchert, M.; Pavel, C.; Marmier, A.; Alves Dias, P.; Blagoeva, D.; Tzimas, E. (2016): Substitution of critical raw materials in low-carbon technologies: lighting, wind turbines and electric vehicles. JRC Science for Policy Report. JRC103284. Joint Research Centre. [https://setis.ec.europa.eu/sites/default/files/reports/crm\\_substitution\\_online\\_report.pdf](https://setis.ec.europa.eu/sites/default/files/reports/crm_substitution_online_report.pdf) (09.02.2021)
- [Schueler et al. 2018] Schueler, D.; Dolega, P.; Degreif, S. (2018): Social, economic and environmental challenges in primary lithium and cobalt sourcing for the rapidly increasing electric mobility sector. [https://www.stradeproject.eu/fileadmin/user\\_upload/pdf/STRADE\\_PB\\_Li\\_Co\\_EMobility.pdf](https://www.stradeproject.eu/fileadmin/user_upload/pdf/STRADE_PB_Li_Co_EMobility.pdf) (08.01.2021)
- [SGL Carbon 2019]: SGL Carbon (2019): Graphite anode material overview and sustainability. Fab4LiB Q1 meeting 2019.
- [SGL Carbon 2020]: Personal Communication with Alberto Biancoli, Ivano Galbiati, Peter Roschger, SGL Carbon (28.07.2020)
- [Shedd et al. 2017]: Shedd, K..B.; McCullough, E. A.; Bleiwas, D. L. (2017): Global trends affecting the supply security of cobalt. *Mining Engineering*. Vol. 69 (12). pp. 37–42. <https://s3-us-west-2.amazonaws.com/prd-wret/assets/palladium/production/mineral-pubs/cobalt/cobalt-supply-security.pdf> (09.01.2021)
- [Shell 2018]: Shell (2018): Recent Developments to Implement UNEP Report Recommendations. <https://www.shell.com.ng/sustainability/environment/unep-environmental-assessmen-of-ogoni-land.html> (25.11.2020)
- [Simpec 2020]: Simpec (2020): Tianqi Lithium - Lithium Hydroxide Processing Plant Stage 1 (LHPP1). <https://www.simpec.com.au/projects/tianqi-lithium-hydroxide-processing-plant-stage-1-lhpp1> (27.07.2020)
- [Slav 2018]: Slav, I. (2018): 200 Dead In Nigeria Oil Pipeline Blast. <https://oilprice.com/Latest-Energy-News/World-News/200-Dead-In-Nigeria-Oil-Pipeline-Blast.html> (26.11.2020)
- [Slav 2020]: Slav, I. (2020): Offshore Oil Is On The Brink Of Collapse. <https://oilprice.com/Energy/Crude-Oil/Offshore-Oil-Is-On-The-Brink-Of-Collapse.html> (12.01.2021)
- [Solsvik 2020]: Solsvik, T. (2020): Norway sovereign wealth fund to divest oil explorers, keep refiners. <https://www.reuters.com/article/us-norway-swf-oil/norway-sovereign-wealth-fund-to-divest-oil-explorers-keep-refiners-idUSKBN1WG4R9> (20.11.2020)
- [SQM 2018]: SQM (2018): Online Monitoring System. <https://www.sqmsenlinea.com/> (13.01.2021)



[Stahl et al. 2021]: Stahl, H.; Mehlhart, M.; Gsell, M.; Sutter, J.; Dolega, P.; Baron, Y.; Löw, C.; Neumann, T.; Williams, R.; Keeling, W.; Oliva, J.; Montevecchi, F. (2021): Oeko-Institut in cooperation with Ramboll, Trinomics B.V. and Umweltbundesamt Wien, European Commission (ed.), publication in preparation.

[Stäude 2019]: Stäude, L. (2019): Kobaltabbau im Kongo - Der hohe Preis für Elektroautos und Smartphones. Deutschlandfunk. [https://www.deutschlandfunk.de/kobaltabbau-im-kongo-der-hohe-preis-fuer-elektroautos-und-724.de.html?dram:article\\_id=454818](https://www.deutschlandfunk.de/kobaltabbau-im-kongo-der-hohe-preis-fuer-elektroautos-und-724.de.html?dram:article_id=454818) (25.01.2021).

[Statistik sentralbyå 2020]: Statistik sentralbyå – Statistics Norway (2019): Electricity. <https://www.ssb.no/en/energi-og-industri/statistikker/elektrisitet/aar> (20.11.2020)

[Steger et al. 2019]: Steger, S.; Ritthoff, M.; Bulach, W.; Schueler, D.; Kosinska, I.; Degreif, S.; Dehoust, G.; Bergmann, T.; Krause, P.; Oetjen-Dehne, R. (2019): Material flow-oriented determination of the contribution of the secondary raw materials industry to conserving primary raw materials and increasing resource productivity - Annex. Umweltbundesamt. Texte 34/2019. <https://www.umweltbundesamt.de/publikationen/stoffstromorientierte-ermittlung-des-beitrags-der> (09.02.2021)

[Stoddard et al. 2012]: Stoddard, E., Lakmidas, S. (2012): "AngloGold says illegal strike spreads in South Africa". JOHANNESBURG: Reuters., 26 September 2012. <https://www.reuters.com/article/2012/09/26/us-safrica-mines-idUSBRE88P0NV20120926> (12.02.2012).

[Stone 2020]: Stone, M. (2020): Russian Indigenous communities are begging Tesla not to get its nickel from this major polluter, 21 Sept. 2020, <https://grist.org/justice/russian-indigenous-communities-are-begging-tesla-not-to-get-its-nickel-from-this-major-polluter/> (12.02.2021).

[Streletskiy et al. 2019]: Streletskiy, D. A.; Suter, L. J.; Shiklomanov, N. I.; Porfiriev, B. N.; Eliseev, D. O. (2019): Assessment of climate change impacts on buildings, structures and infrastructure in the Russian regions on permafrost. *Environmental Research Letters*. Vol. 14 (2), 025003. <https://iopscience.iop.org/article/10.1088/1748-9326/aaf5e6/meta> (08.01.2021).

[Strittmatter 2020]: Strittmatter, K. (2020): Norwegens Regierung eröffnet ein gewaltiges Ölfeld. <https://www.sueddeutsche.de/wirtschaft/norwegen-erdoel-johan-sverdrup-1.4747060> (20.11.2020).

[SubSKrit 2019]: Buchert, M.; Degreif, S.; Bulach, W.; Schueler, D.; Prakash, S.; Möller, M.; Köhler, A.; Behrendt, S.; Nolte, R.; Röben, A. (2019): Substitution as a strategy to reduce the criticality of raw materials for environmental technologies - potential identification for second-best solutions. Umweltbundesamt (ed.). UBA-Texte 03/2019. <https://www.umweltbundesamt.de/publikationen/substitution-als-strategie-minderung-rohstoffkritikalitaet> (09.02.2021)

[Talisson Lithium 2021]: Talisson Lithium (2021): Greenbushes Project. <https://www.talisonlithium.com/greenbushes-project> (6.01.2021)

[The Hill 2020]: The Hill; Frazin, R.; Beitsch, R. (2020): Trump administration could pursue drilling near Florida coast post-election: report. <https://thehill.com/policy/energy-environment/502048-trump-administration-to-pursue-drilling-near-florida-coast-post> (12.01.2021)

[The Irrawaddy 2021]: Illegal Rare Earth Mines on China Border Multiply Since Myanmar's Coup: <https://www.irrawaddy.com/news/burma/illegal-rare-earth-mines-china-border-multiply-since-myanmars-coup.html> (27.05.2021)



- [The Maritime Executive 2007]: The Maritime Executive (2007): Second Largest Norwegian Oil Spill. <https://www.maritime-executive.com/article/2007-12-20second-largest-norwegian-oil-spill> (23.11.2020)
- [The Texas Tribune 2020]: The Texas Tribune; Ferman, M. (2020): Texas agency won't cut oil production despite cratering prices. <https://www.texastribune.org/2020/05/05/texas-oil-production-cuts-railroad-commission/> (12.01.2020)
- [Thompson 2018]: Thompson, J. (2018): Trump's policies aren't actually fueling a fracking boom. <https://www.hcn.org/articles/natural-gas-trumps-policies-arent-actually-fueling-a-fracking-boom>
- [Tsurukawa et al. 2011]: Tsurukawa, N.; Prakash, P.; Manhart, A. (2011): Social impacts of artisanal cobalt mining in Katanga, Democratic Republic of Congo. <https://www.oeko.de/oekodoc/1294/2011-419-en.pdf> (08.01.2021)
- [UNEP 2011 A] Graedel, T.E; Allwood, J; Birat, J-P; Reck, B.K; Sibley, S.F; Sonnemann, G; Buchert, M; Hagelüken, C. (2011) Recycling Rates of Metals – A Status Report. A Report of the Working Group on Global Metal Flows to the International Resource Panel.. <https://www.resourcepanel.org/reports/recycling-rates-metals> (11.02.2021)
- [UNEP 2011 B]: United Nations Environment Programme, UNEP (2011): Environmental Assessment of Ogoniland. <https://www.unenvironment.org/resources/assessment/environmental-assessment-ogoniland-site-factsheets-executive-summary-and-full> (25.11.2020)
- [UNEP 2017]: United Nations Environment Programme, UNEP (2017): Nigeria Launches \$1 Billion Ogoniland Clean-up and Restoration Programme. <https://www.unenvironment.org/news-and-stories/story/nigeria-launches-1-billion-ogoniland-clean-and-restoration-programme> (25.11.2020)
- [USGS 2017]: United States Geological Survey , USGS (2017): Critical mineral resources of the United States—Economic and environmental geology and prospects for future supply. <https://pubs.er.usgs.gov/publication/pp1802> (08.12.2020)
- [USGS 2019 A]: United States Geological Survey , USGS (2019): Graphite Data Sheet - Mineral Commodity Summaries. <https://prd-wret.s3.us-west-2.amazonaws.com/assets/palladium/production/s3fs-public/atoms/files/mcs-2019-graph.pdf> (07.12.2020)
- [USGS 2019 B]: United States Geological Survey, USGS (2019): Mineral Commodity Summaries 2019. [https://prd-wret.s3-us-west-2.amazonaws.com/assets/palladium/production/atoms/files/mcs2019\\_all.pdf](https://prd-wret.s3-us-west-2.amazonaws.com/assets/palladium/production/atoms/files/mcs2019_all.pdf) (12.01.2021)
- [USGS 2020 A]: United States Geological Survey , USGS (2020): Mineral Commodity Summaries 2020. <https://pubs.usgs.gov/periodicals/mcs2020/mcs2020.pdf> (07.12.2020).
- [USGS 2020 B]: United States Geological Survey , USGS; McShane, R. R.; Barnhart, T. B.; Valder, J. F.; Haines, S. S.; Macek-Rowland, K. M.; Carter, J. M.; Delzer, G. C.; Thamke, J. N. (2020): Estimates of water use associated with continuous oil and gas development in the Williston Basin, North Dakota and Montana. 2007–17. Scientific Investigations Report 2020-5012. <https://pubs.er.usgs.gov/publication/sir20205012> (27.11.2020)
- [USGS 2021 A]: United States Geological Survey, USGS (2020): Platinum Group Metals. Mineral Commodity Summaries 2020. <https://pubs.usgs.gov/periodicals/mcs2021/mcs2021-platinum.pdf> (01.02.2021)

USGS 2021 B]: United States Geological Survey, USGS (2020): Rare Earths. Mineral Commodity Summaries 2020. <https://pubs.usgs.gov/periodicals/mcs2021/mcs2021-rare-earths.pdf> (01.02.2021)

[VDA 2009]: Verband der Automobilindustrie (2009): Future Drive Systems and Fuels. Frankfurt am Main.

[Washington Post 2016]: Whoriskey, P. (2016): In your phone, in their air. <https://www.washingtonpost.com/graphics/business/batteries/graphite-mining-pollution-in-china/> (07.12.2020)

[Whitehouse 2019]: Whitehouse, D. (2019): Glencore's Mutanda closure may be bargaining tactic with DRC <https://www.theafricareport.com/16284/glencores-mutanda-closure-may-be-bargaining-tactic-with-drc/> (08.01.2021)

[World Bank 2020]: World Bank (2020): Worldwide Governance Indicators. <https://info.worldbank.org/governance/wgi/Home/Reports> (20.01.2021)

[Wurm et al. 2018]: Wurm, C.; Oettinger, O.; Wittkaemper, S.; Zauter, R.; Vuorilehto, K. (2018): Anode materials for lithium-ion batteries. *Lithium-Ion Batteries: Basics and Applications*. Bd. 5, pp. 44–57. <https://www.springerprofessional.de/anode-materials-for-lithium-ion-batteries/16019168> (09.02.2021)

[Xinhua 2020]: Xinhua (2020): Libya seeks to increase oil, gas trade with Spain. <https://africa.cgtn.com/2020/11/20/libya-seeks-to-increase-oil-gas-trade-with-spain/>

[Ydersbond 2014]: Ydersbond, I. M. (2014): Aiming to be environmental leaders, but struggling to go forward: Sweden and Norway on energy system transformation. *Energy Procedia*. Vol. 58. pp. 16–23. <https://doi.org/10.1016/j.egypro.2014.10.403>

[Zadikian 2020]: Zadikian, M. (2020): Suncor CEO blasts Norway; says oil sands divestment 'not founded in fact'. <https://www.bnnbloomberg.ca/suncor-ceo-blasts-norway-oil-sands-divestment-not-founded-in-fact-1.1447987> (20.11.2020)

[Zhihua et al. 2021]: Zhihua, L.; Yukun, L. (2021): China to step up protection of rare earth resources, China Daily Global, 19 Jan. 2021, <http://epaper.china-daily.com.cn/a/202101/19/WS60062bf7a31099a2343535a6.html> (15.02.2021).