

# Pointing the way for society

Annual Report of the Oeko-Institut 2016

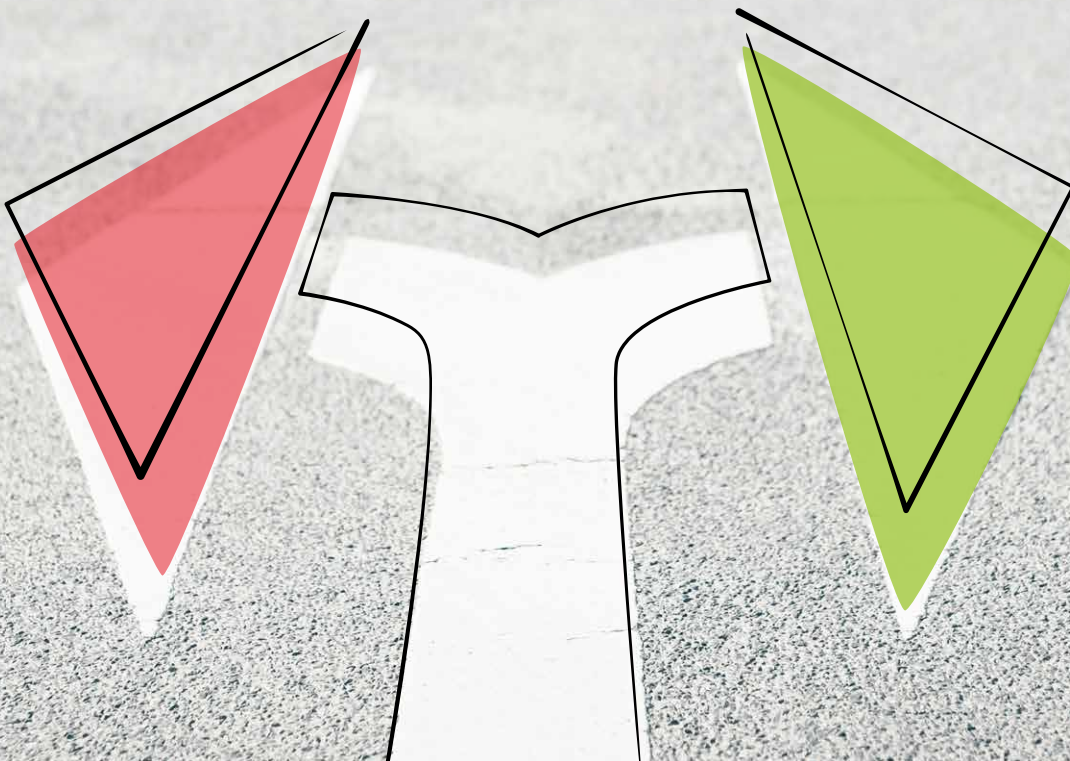

# Knowledge – the basis for action

## Sustainable transport for greater quality of life

“Green transport” takes many forms – such as cycling, public transport and e-vehicles powered by renewable electricity. The transport of tomorrow is coupled to urban quality of life and plays a part in combating climate change. See page 13.

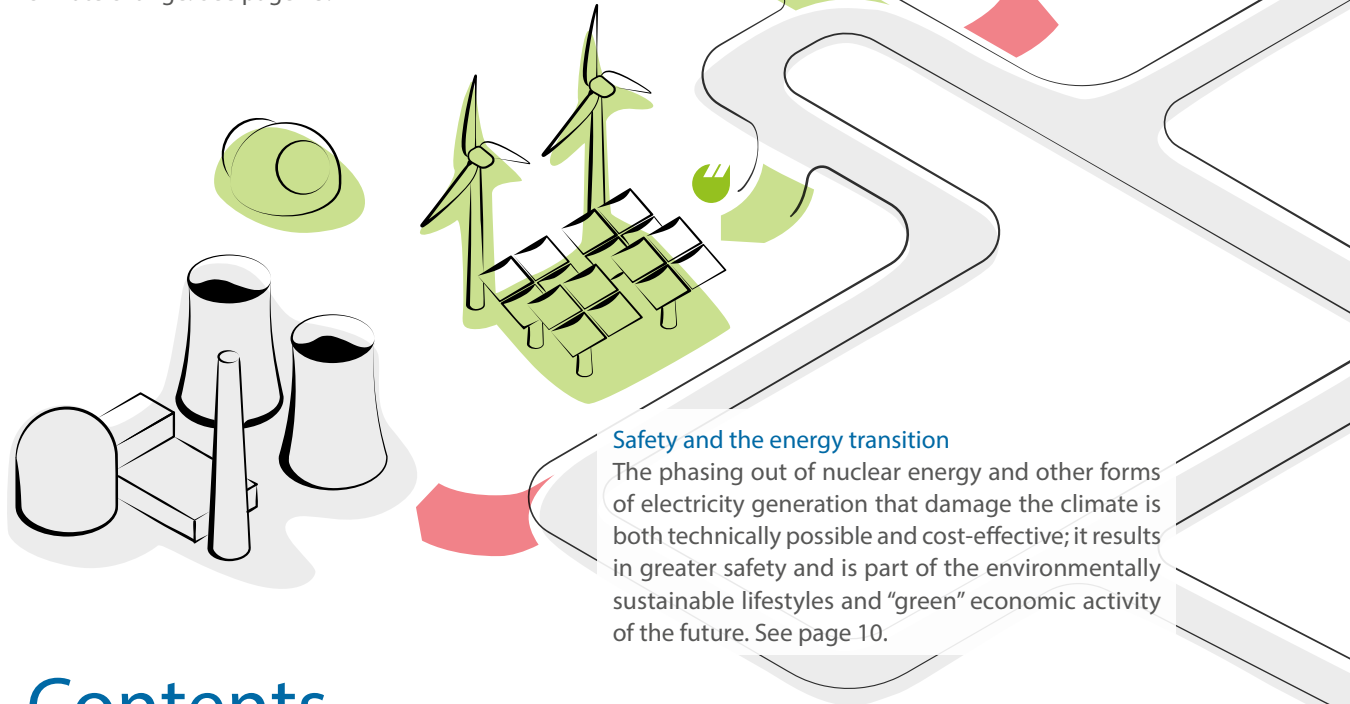

## Safety and the energy transition

The phasing out of nuclear energy and other forms of electricity generation that damage the climate is both technically possible and cost-effective; it results in greater safety and is part of the environmentally sustainable lifestyles and “green” economic activity of the future. See page 10.

## Contents

<b>Our year 2016</b>	4	<b>Cadmium in TV screens</b>	14
Editorial by Michael Sailer, CEO of the Oeko-Institut		Exemption requests under the RoHS Directive	
<b>Our work – Pointing the way for society</b>	6	<b>A new pillar</b>	15
<b>Facts and figures for 2016</b>	7	Reducing carbon emissions in agriculture and forestry	
<b>Towards a sustainable society</b>	8	<b>Safety: not good enough</b>	16
Selected projects from 2016		The Beznau and Fessenheim nuclear power plants	
<b>Sustainable raw material use</b>	9	<b>Changing attitudes to consumption</b>	17
A timetable for Germany 2049		Strategies to counter obsolescence	
<b>Encouraging acceptance of restructuring</b>	10	<b>The technologised plant</b>	18
Transforming the energy system		Breeding between patents and variety rights	
<b>Appropriate participation</b>	11	<b>The Oeko-Institut’s clients</b>	19
Involving residents near nuclear facilities		<b>Paving the way for the future</b>	20
<b>80 percent less energy</b>	12	The structure and management of the Oeko-Institut	
Climate action in buildings		<b>Many ways of communication</b>	22
<b>Climate-friendly transport</b>	13	<b>Hand-in-hand with society</b>	23
The Renewbility research project		The Oeko-Institut’s members	

### Conscious purchasing decisions and living well

Making conscious purchasing decisions means buying high-quality, long-life and easily recyclable products manufactured to high environmental and social standards. This not only helps to protect the climate and conserve resources but also contributes to fairer global working conditions. More on page 17.

### Fair working conditions for the transition to a sustainable use of raw materials

A sustainable raw materials policy must involve both the environmentally responsible extraction of raw materials on the one hand and the efficient use and recovery of raw materials – some of which are very valuable – on the other. See page 9.

## Published by



© Oeko-Institut e.V.  
Institute for Applied Ecology  
March 2017

Edited by:  
Mandy Schossig (responsible)  
Christiane Weihe, [www.wortspektrum.de](http://www.wortspektrum.de)

Oeko-Institut, Berlin Office  
Schicklerstrasse 5-7  
10179 Berlin  
[redaktion@oeko.de](mailto:redaktion@oeko.de)  
[www.oeko.de](http://www.oeko.de)

Design and layout:  
Bertram Sturm, [www.bertramsturm.de](http://www.bertramsturm.de)

Printed by:  
LokayDruck, [www.lokay.de](http://www.lokay.de)  
Printed on 100% recycled paper

# Our year 2016

## Dear readers,

Many people will remember 2016 as the year of events that called into question some of our basic beliefs. In opting for Brexit, the British electorate voted against remaining in the European Union. The number of terrorist atrocities increased, and in electing Donald Trump the USA chose a president who does not believe that climate change is caused by humans and has appointed a died-in-the-wool climate sceptic as head of the US Environmental Protection Agency. Of course there were also positive developments, such as the ratification of the Paris climate agreement by the two largest emitters of CO<sub>2</sub>, China and the USA, and the scientists' finding that the ozone layer is thickening again and the ozone hole may close completely. The first of these examples, in particular, shows that many countries have a definite interest in actively helping to protect the environment. And it is not just the major "old" industrialised nations who are doing this, but also emerging newly industrialised nations – a fact that renders old notions of "us" and "them" increasingly obsolete.

The past year was eventful and it raises social and political challenges that we shall have to face up to in 2017. Many things are still unclear: what will become of the large-scale movements of refugees? Will it prove possible to curb the devastating conflicts that are causing so many people to flee? How will governments all over Europe respond to people's fears about jobs and to the economic situation as a whole? And quite specifically, how will the energy transition continue – in Germany but in particular worldwide? Some of these issues have a direct bearing on the topics that concern us every day at the Oeko-Institut, while others have many indirect implications for us. We shall continue to work on solutions for a globally fair resource policy, on approaches to international climate change mitigation that see protecting the habitats of people, animals and plants as one of the goals of climate action, on pointing out that protecting the environment often protects human rights at the same time, and on proposals for sustainable economic development overall.

## Facts, facts!

At the same time, we believe that it is not only in connection with the environment that facts are more necessary than ever. Knowledge-based communication that also speaks to people emotionally must be the order of the day. In addition, our societies must be cohesive and not allow themselves to

be divided by individuals or groups. This is essential if we are to talk about problems and look for joined-up solutions. At the Oeko-Institut we remain actively committed to this approach. Our purpose is clear: to provide knowledge and information that can serve as a basis for balanced and forward-looking decisions. Political decisions. Business decisions. And also personal decisions, such as consumer-related ones. We have been performing this signposting role for 40 years and last year we continued this work by publishing a number of research studies, some of them quite groundbreaking. For example, we completed a major study into the issues behind the obsolescence – the ever-shorter lifetime and usage – of electrical and electronic equipment, as well as small but important studies of the legal conditions that apply to plant breeding. We are constantly exploring issues that are the subject of social debate and putting forward proposals that address the problems involved in sustainability-oriented ways.

Another project, and one that I would particularly like to highlight, is our self-financed project on the shift in the use of raw materials ("Rohstoffwende"). Over the last three years we have been developing a concept that describes how the sustainable resource economy of the future could be achieved. The key finding of the researchers involved in the project is that the sheer diversity of raw materials calls for specifically tailored targets and measures to address the various environmental and social problems associated with extraction, use and disposal. A simple solution along the lines of "reduce consumption by X percent" is incompatible with a realistic and sustainable raw materials policy. Instead the clear message is that there must be customised strategies for the different material groups that take account of the issues prevailing within each. This nuanced concept was very well received at our annual scientific conference; we shall now work on feeding our ideas into the political process at German, European and international level.

These and other important scientific studies this year are described in this Annual Report, which I warmly invite you to read.

## The Oeko-Institut turns 40

I should like to take this opportunity to tell you about an event that is particularly exciting for us at

the Oeko-Institut. In November 2017 – on 5 November, to be precise – we shall be forty years old. That is 40 years of active involvement in environmental policy, 40 years of thinking about the best ways to protect nature and the environment, 40 years of dialogue with all sectors of society. We shall be celebrating and looking back. At the same time, though, we plan to use the anniversary as a time to look forward and to specify what we would like to see happen in the next ten, twenty or forty years. We shall be launching our anniversary period in May: we invite you to celebrate with us on the Web and in person, and to continue challenging us.

I hope that you enjoy reading our Annual Report and that 2017 is an exciting and successful year for both you and us.

With very best wishes,

Yours



**Michael Sailer**  
Chief Executive Officer of the Oeko-Institut

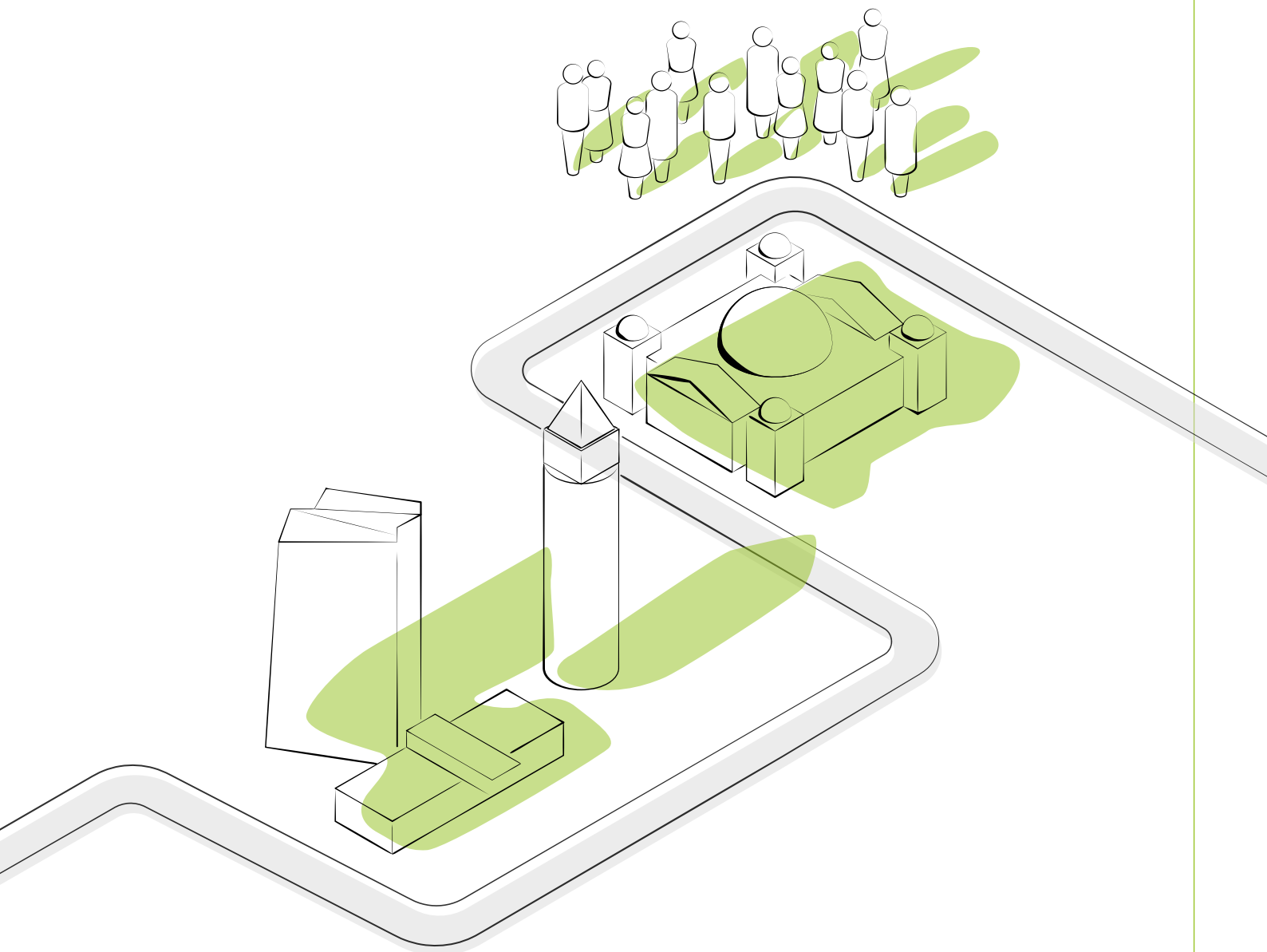

# Our work – Pointing the way for society

## The Oeko-Institut's mission statement

*“The aim of our work is to contribute to the preservation of the environment and of natural resources, and to ensure the foundation on which all human life depends, for present and future generations. Oriented at finding solutions, we apply our ideas, our scientific expertise and our consulting capabilities to initiate and form the necessary transformations of policy and society. We believe that such transformation processes must be democratic and equitable – also on the international level. Realising this vision and promoting sustainable transformations at present and in the future, drives and motivates our everyday work.”*

These are the opening sentences of the Oeko-Institut's mission statement, which we revised last year. We wanted to shorten the original mission statement drawn up by the Institute in a broad-based internal process in 2005, and to make the wording clearer and more succinct. In particular, we aimed to place greater emphasis on the core elements of our scientific and technical work and to adapt the layout to contemporary standards.

Most of the work was carried out by a “mission statement” working group which produced a new proposal, collated the comments of staff and discussed the draft with the Institute's bodies. The result of the lively, dynamic and creative process is a mission statement that reflects the Oeko-Institut's concept of itself, describes our basic principles, values and areas of work and hence shows what the Institute stands for both internally and externally.

Read the Oeko-Institut's mission statement:  
[www.oeko.de/en/the-institute/mission-statement/](http://www.oeko.de/en/the-institute/mission-statement/)

## Researching, analysing, advising – creating knowledge for tomorrow

The mission statement describes in clear and succinct words what the day-to-day work of the Oeko-Institut is about: our work helps to solve environmental and sustainability problems. In Germany and elsewhere. In the short, medium and long term. Specifically and comprehensively. We bring together knowledge that society, policy-makers and businesspeople can use to make the necessary changes – transformations. We advise stakeholders on implementation. We explore new pathways and describe alternative approaches to achieving the transitions in energy, transport, raw materials, etc. Our scientific work is always in close touch with society – no matter whether we are acting as a knowledge provider, an advisor, or a source of ideas, or whether the issue is climate action, resource efficiency, nuclear safety or sustainability in IT. We see our work as laying the foundation for a safe, fair and liveable future.

Comprehensive information on our research and consultancy: [www.oeko.de/en/research-consultancy/](http://www.oeko.de/en/research-consultancy/)

## Some sustainability facts

In mid-2016 the Oeko-Institut published its comprehensive sustainability audit – some facts and figures are shown here.

You can read the Oeko-Institut's full Sustainability Report (in German language) here:  
[www.oeko.de/nachhaltigkeitsbericht](http://www.oeko.de/nachhaltigkeitsbericht)

# Facts and figures for 2016

## Human resources

In 2016 we had almost 170 members of staff, including 120 researchers, working on issues relating to the sustainable organisation of our society. They are employed at the Institute's offices in Freiburg (63 people), Darmstadt (50) and Berlin (56).

## Human resources 2000 – 2016

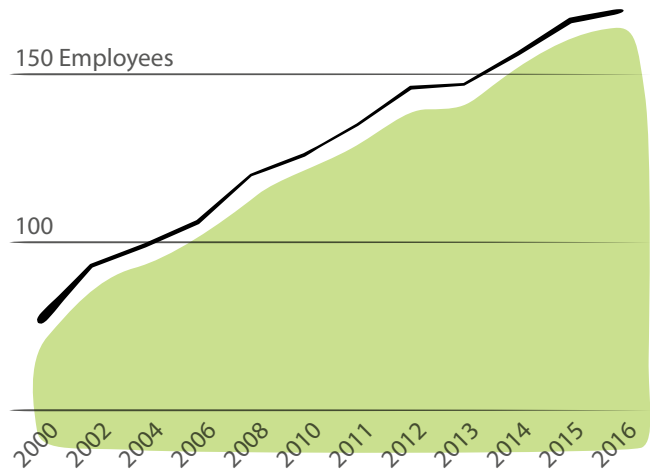

## Projects and turnover

Last year the Oeko-Institut's researchers worked on more than 380 projects. The Institut's total turnover was in excess of 15 million euros (target figure). Key projects commissioned by our clients came from politics, business and civil society.

## The Oeko-Institut's turnover 2000 – 2016

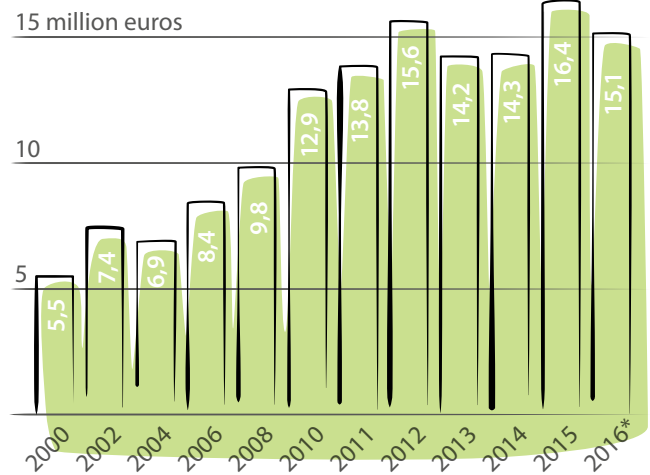

\*Target figure

### The Oeko-Institut's paper consumption

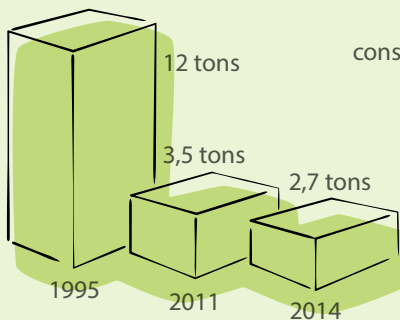

### Comparison 1994 – 2014 (Energy and resource consumption)

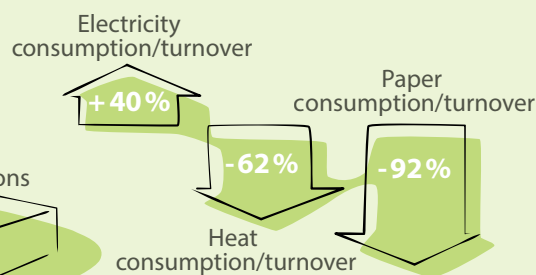

### The percentage of women at the Oeko-Institut

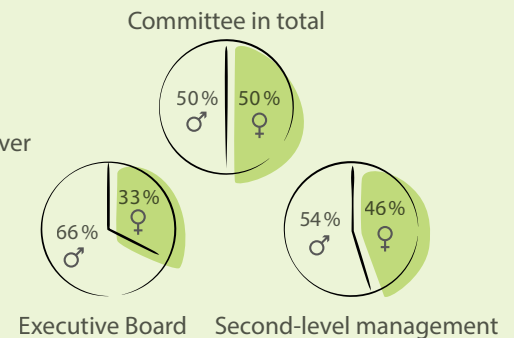

# Towards a sustainable society

## Selected projects from 2016

2016 presented our society with major challenges. Wars, terrorism, surprising election decisions. Natural disasters close to home and on other continents. But there were also moments of encouragement for the future – such as the ratification of the Paris climate agreement by the two largest emitters of CO<sub>2</sub>, China and the USA. The Oeko-Institut seeks to promote sustainable change by providing policy-makers and society with ideas that can kick-start transformation. We are committed to the sustained protection of nature and the environment and the conservation of the foundations of life for all people.

The annual report profiles ten projects that illustrate how the Oeko-Institut's researchers contributed to the sustainable transformation of our society in 2016. On the following pages we describe an inter-divisional project that explores the environmentally sound and socially equitable transformation of the energy system, and a report from the Environmental Law & Governance Division on the legal conditions for plant breeding. The Energy & Climate Division has produced a study that examines how Germany's building stock could become climate-neutral by 2050, as well as a

study of emission reductions in agriculture and forestry. In 2016 the Resources & Transport Division worked on a project that shows how particularly undesirable consequences of raw material use can be minimised and addressed the question of whether a fully decarbonised transport system can be achieved by 2050.

To illustrate the work of the Nuclear Engineering & Facility Safety Division, we profile two reports produced by the Oeko-Institut on safety issues at the Fessenheim and Beznau nuclear power plants, and also a study of the participation of people living near nuclear facilities. Finally, the researchers of the Sustainable Products & Materials Flows Division report on an extensive study of the shortened lifetime and duration of use of electrical and electronic equipment, known as obsolescence, and on the evaluation of exemption requests for the use of hazardous substances in electrical and electronic products.

In profiling these ten projects we want not only to look back but also to outline what remains to be done. For people and the environment. For us and for others. For a viable society, in 2016 and beyond.

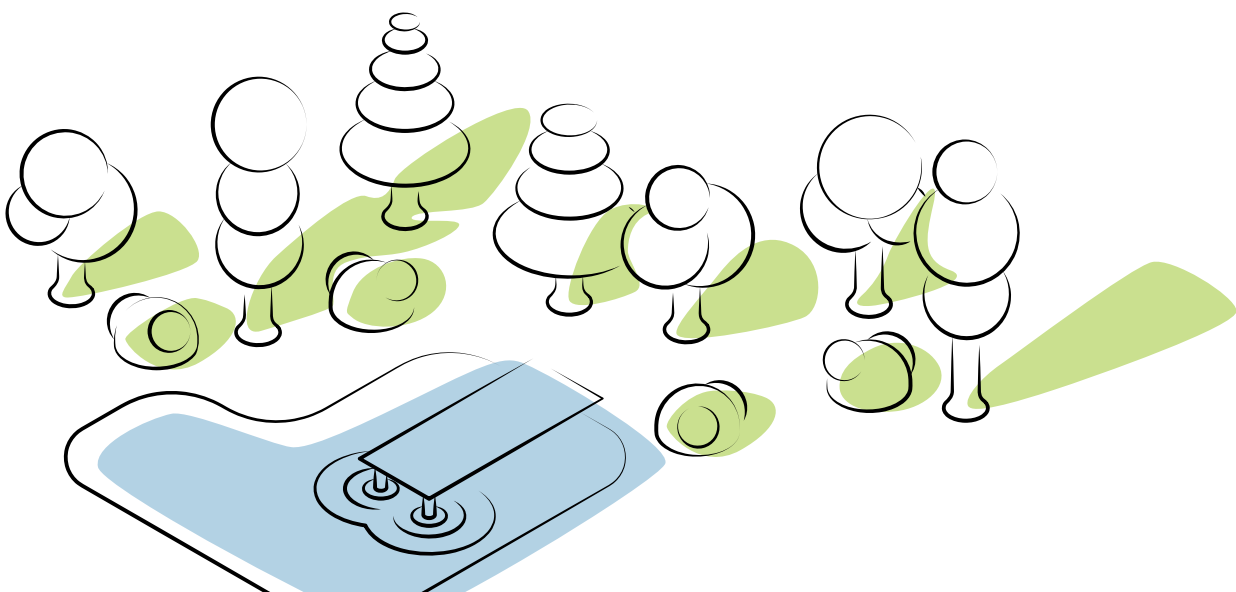



# Sustainable raw material use

## A timetable for Germany 2049

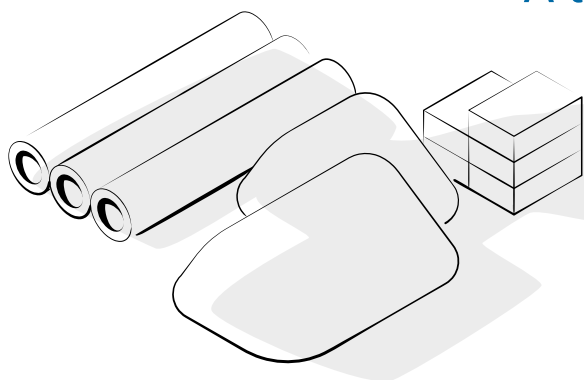

**Cement for buildings, lithium for batteries, steel for cars – Germany is a hungry consumer of raw materials. It is an industrialised country in which there is strong demand for both imported raw materials and those sourced in Germany. But the extraction of these materials can have serious social, economic and environmental consequences. The Oeko-Institut’s self-financed project “Germany 2049: Transition to a sustainable use of raw materials” highlights what can be done to minimise the particularly undesirable consequences of resource use.**

The project team has drawn up a long-term strategy for sustainable resource management in Germany, focusing on 75 abiotic raw materials – ores, industrial materials and construction materials, including tin, potash, gravel and neodymium. The researchers started by analysing the economic, environmental and social impacts of these materials – such as disposal risks, pollutant emissions and child labour – and identifying particularly relevant adverse consequences of resource extraction, known as “hot spots”. For example, for gravel, which is a bulk raw material sourced in Germany, one of the major risks is the consumption of land, while for the high-tech metal neodymium a significant issue is the radioactive residue produced during extraction and refinement.

Next, the project team outlined material-specific targets and measures for achieving them in four areas of need: housing, transport, work, and information

and communication technologies (ICT). In the case of gravel there is a need for policy guidelines to increase the use of recycled building materials and reduce primary demand. For neodymium, which is used in environmental technologies and can thus help to cut resource use, the project team recommends not only measures such as recycling to reduce the use of primary material but also certification of sustainably extracted resources. In addition, the researchers compare two scenarios – one predicated on business-as-usual and one on a transition to sustainable resource use – in order to show what a sustainable raw materials policy could achieve. For example, demand for primary gravel could be reduced by about 50 percent by 2049, and by the same year the percentage of primary demand for neodymium that is met from certified resources could be increased to 80 percent.

### Project profile

**Project title:** Germany 2049: Transition to a sustainable use of raw materials

**Contact:** Stefanie Degreif, [s.degreif@oeko.de](mailto:s.degreif@oeko.de),  
Dr Matthias Buchert (Project Manager),  
[m.buchert@oeko.de](mailto:m.buchert@oeko.de)

**Institute Division:** inter-divisional

**Funding:** Oeko-Institut (self-financed)

**Timescale:** June 2014 – December 2016

**Further information:**

[www.oeko.de/rohstoffwende2049](http://www.oeko.de/rohstoffwende2049)

### Stefanie Degreif

Stefanie Degreif, who has a degree in geography, joined the Oeko-Institut in 2010. In her work she focuses on resources, looking at issues such as the environmental impacts of resource extraction and opportunities for sustainable raw materials management.

*“The 75 raw materials that were analysed vary widely in terms of both the environmental and social impacts of primary extraction and appropriate targets for a sustainable resource policy. In the case of gravel, for example, the aim should be to reduce primary demand by 2049, while in the case of neodymium, which is important for environmental technologies, the percentage of sustainably extracted primary material should be increased.”*



# Encouraging acceptance of restructuring Transforming the energy system



The transition to a sustainable energy system brings with it many challenges – in connection with both the expansion of renewables and electricity grids and the reduction of energy consumption. The transition cannot be achieved without the acceptance of the general public, and appropriate ways of involving the public in the restructuring of the system must therefore be found. Thirty-three inter- and transdisciplinary projects funded by the German Federal Ministry of Education and Research have addressed these challenges and worked with partners in the field to identify solutions. Scientific coordination and support of the research programme were provided by the Oeko-Institut and ISOE – the Institute for Social-Ecological Research.

transfer workshops on issues such as “efficiency and sufficiency” and energy cooperatives.

The Oeko-Institut and ISOE are conducting a detailed evaluation of all the projects from the point of view of participation. This analysis is examining participatory research methods as well as findings and recommendations on the participation of the general public in planning processes. As a result, the research projects are sparking changes in current participation processes and in the responsibilities and roles of stakeholders in these processes.

Several projects looked at the question of the extent to which the electricity system of the future should be distributed or centralised. The project “Transparency in electricity grids”, which was implemented by the Oeko-Institut itself, considered alternatives to grid expansion. It concluded that expansion can sometimes be avoided, but only if alternatives are put in place, such as additional generating capacity in southern Germany. The programme also explored ways of reducing the energy demand of buildings.

Proposals include more extensive obligations to upgrade existing buildings and novel approaches for socially equitable allocation of the costs of upgrades.

The task of the Oeko-Institut and ISOE was to facilitate communication between the 33 research projects and promote transfer of the results into practice. The programme’s key findings were presented at a closing conference in October 2016 and their application potential was discussed in additional

## Project profile

**Project title:** Environmentally sound and socially equitable transformation of the energy system

**Contact:** Dirk Arne Heyen, [d.heyen@oeko.de](mailto:d.heyen@oeko.de)  
Prof. Dr Rainer Griesshammer (Project Manager),  
[r.griesshammer@oeko.de](mailto:r.griesshammer@oeko.de)

**Institute Division:** Environmental Law & Governance, Energy & Climate, Sustainable Products & Material Flows

**Funding:** German Federal Ministry of Education and Research (BMBF)

**Project partners:** ISOE – the Institute for Social-Ecological Research, kib research

**Timescale:** April 2014 – August 2017

**Further information:**  
[www.transformation-des-energiesystems.de](http://www.transformation-des-energiesystems.de)

## Dirk Arne Heyen

Dirk Arne Heyen, a political scientist who joined the Oeko-Institut in 2011, works on social change processes, lifestyle and consumption issues and the role of the state in these areas.

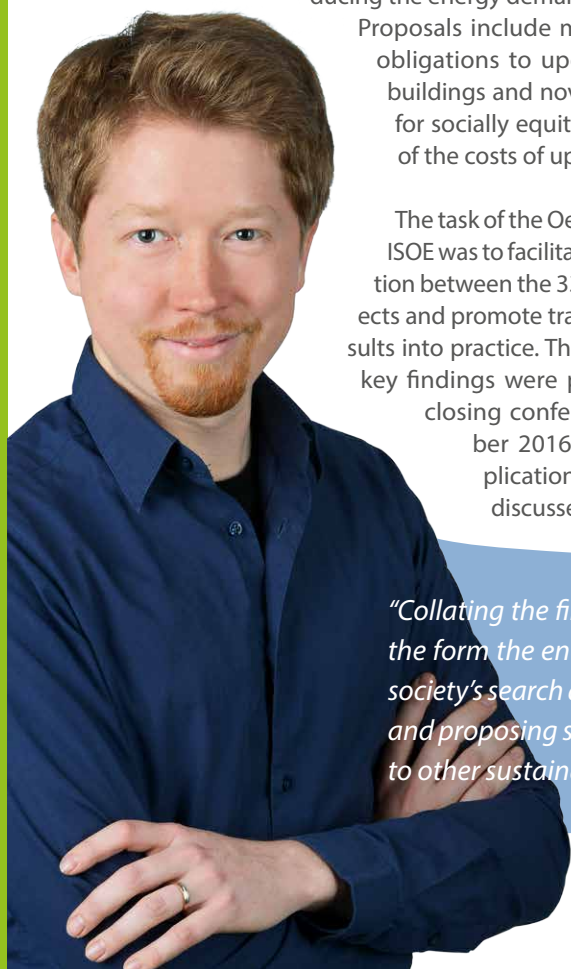

*“Collating the findings of 33 research projects provides valuable information on the form the energy transition could take. We see our task as being to facilitate society’s search and decision-making process by making our knowledge available and proposing suitable solutions. We can also draw conclusions that are relevant to other sustainability-oriented transformation processes.”*

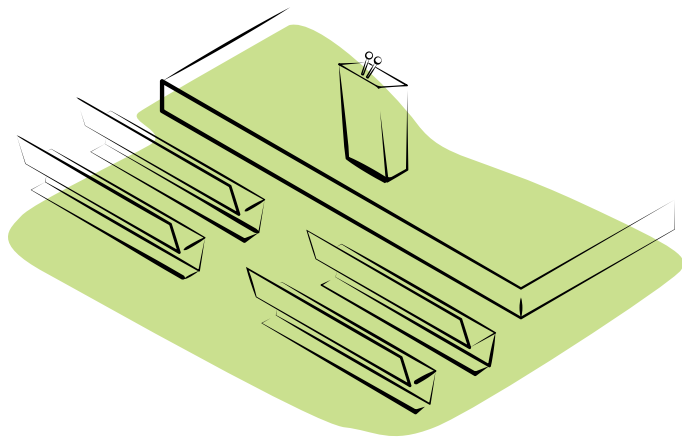

# Appropriate participation

## Involving residents near nuclear facilities

**Two kilometres away a nuclear power plant is being dismantled; an interim repository for radioactive waste is planned. What does this mean for local residents? Are there risks – and if so, what are they? What opportunities do local people have to influence the process? Public consultation measures can help to alleviate the anxieties of people living near nuclear facilities and answer their questions. When organised appropriately, they also give residents and interest groups an opportunity to put forward wishes and ideas that can be taken into account when decisions are made. But how effective are these procedures and is there scope for improvement? The Oeko-Institut has been considering these issues on behalf of the Baden-Württemberg Ministry of the Environment.**

The investigation covered both formal, statutorily prescribed participation measures – such as the public hearings that were held in connection with the closure of the Neckarwestheim 1 and Philippsburg 1 nuclear power plants – and informal procedures, such as the public dialogue conducted by the operator EnBW at these sites. For the analysis the Oeko-Institut used telephone interviews and a workshop to collect information on the experiences of people who had participated in the consultation processes and solicit their suggestions for improvements.

The analysis shows that the Baden-Württemberg Ministry of the Environment is already conducting an open and transparent dialogue in connection with the planning of interim repositories and the decommissioning of nuclear power plants. This enables local people to obtain information about the project and its potential drawbacks and to communicate with the plant operator and the supervisory authorities. However, the study also suggests ways in which participation mechanisms could be improved. For exam-

ple, the public often need to be made more aware of the objectives of a particular participation format and of the opportunities for influence that it affords. The experts also recommend improvements to the documents and information provided: they should be available both in an easily understood form and in a version that goes into considerable technical detail. And additional discussion opportunities are recommended, to supplement events such as the formal hearings.

### Project profile

**Project title:** Analysing various participation formats for people living near nuclear plants and facilities

**Contact:** Beate Kallenbach-Herbert,  
[b.kallenbach@oeko.de](mailto:b.kallenbach@oeko.de)

**Institute Division:** Nuclear Engineering & Facility Safety

**Client:** Baden-Württemberg Ministry of the Environment, Climate and Energy

**Timescale:** September 2015 – March 2016

**Further information:**  
[www.oeko.de/umfeldkkw](http://www.oeko.de/umfeldkkw)

### Beate Kallenbach-Herbert

Beate Kallenbach-Herbert studied mechanical engineering at university and joined the Oeko-Institut in 1998. She produces reports and expert opinions on issues such as the decommissioning of nuclear facilities and the disposal of radioactive waste. She has been head of the Nuclear Engineering & Facility Safety Division since the end of 2009.



*“The Oeko-Institut’s lawyers were also involved in drawing up suggestions for improvements. One of their recommendations is that the formal public consultation process should be improved, especially in long-term and multi-stage licensing procedures. This would entail amending the rules of procedure under nuclear law.”*

# 80 percent less energy

## Climate action in buildings

Germany could have an almost climate-neutral building stock by 2050 – given the right conditions. Buildings can help to mitigate climate change and primary energy demand can be significantly reduced, but only if the appropriate conditions – such as statutory requirements and incentive systems – are in place. On behalf of the German Environment Agency, the Oeko-Institut and the Fraunhofer Institute for Solar Energy Systems ISE have investigated how the energy requirements of buildings can be reduced, what part renewables should play in covering the remaining demand and what costs arise in connection with both aspects.

For the study the researchers defined “target states” that achieve a climate-neutral building stock by different pathways. Each scenario assumes a different upgrade level and differing proportions of renewable energy use. For example, the amount of final energy used could be reduced by about 60 percent if all buildings that can in principle be upgraded are retrofitted with passive house components. For an almost climate-neutral building stock, it would then be necessary to meet slightly more than half the remaining energy need from renewables. If renovation reduces the final energy need by only 35 percent, renewables must supply more than 80 percent of the remaining energy needed; this scenario uses more than 50 terawatt-hours more electricity than the most economical target state. While

the annual costs of this scenario are somewhat lower, the differences between the target states in terms of total costs are very small.

The Oeko-Institut emphasises that the process of achieving a climate-neutral building stock must be backed up by political measures. Relevant steps include the introduction of better financial conditions for retrofits that meet the ambi-

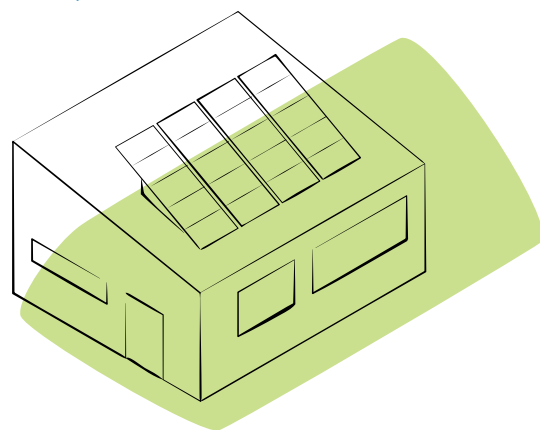

tious KfW standards, and the introduction of target values for energy consumption or CO<sub>2</sub> emissions in 2050 that property owners must use for guidance. In addition, rules and incentives must be brought in that encourage a shift to renewable energies and low-temperature heat distribution systems. To avoid adding to the pressure on the expansion of renewables, it is extremely important to reduce the energy requirements of buildings.

### Project profile

**Project title:** Climate-neutral building stock by 2050

**Contact:** Dr Tilman Hesse, [t.hesse@oeko.de](mailto:t.hesse@oeko.de)

Dr Veit Bürger (Project Manager), [v.buerger@oeko.de](mailto:v.buerger@oeko.de)

**Institute Division:** Energy & Climate (Freiburg)

**Client:** German Environment Agency UBA

**Project partners:** Fraunhofer Institute for Solar Energy Systems ISE

**Timescale:** June 2013 – April 2016

**Further information:** [bit.ly/2fhOn2X](http://bit.ly/2fhOn2X)

### Dr Tilman Hesse

Dr Tilman Hesse is a natural scientist who has been with the Oeko-Institut since 2013. The issues that he works on at the Institute include energy efficiency in buildings, assessment of political (climate protection) instruments at federal and Land level, and the use of renewable energies in the heating sector.

*“One of the German government’s targets is to reduce the primary energy consumption of buildings by 80 percent by 2050. However, to meet the climate targets set in Paris the supply of heat to buildings will have to be almost completely decarbonised. In view of the long investment cycles in the building sector, the measures that are needed to achieve this must be stepped up now.”*

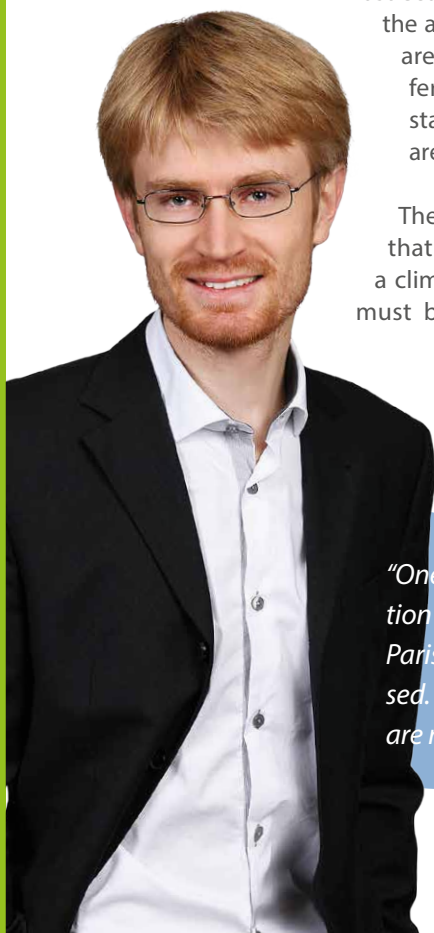

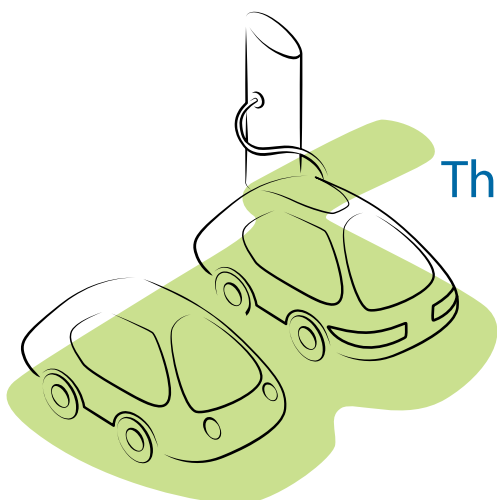

# Climate-friendly transport

## The Renewbility research project

In addition, the project team has analysed the economic costs of a radical shift in the transport sector: according to Renewbility III, strong market penetration by e-vehicles and an increase in rail freight traffic could actually have positive long-term effects. This would be achieved partly through a reduction in external costs, such as the costs of accidents and the burden on the health sector as a result of airborne pollutants. The study calculates that external costs could be reduced by up to 20 billion euros by 2050.

**Germany's climate targets cannot be achieved without addressing the transport sector. But its greenhouse gas emissions have not fallen over the years. Is radical reversal of this situation possible: could we have zero greenhouse gas emissions from transport by 2050? Yes, say the experts at the Oeko-Institut. With the Institute for Transport Research at the German Aerospace Centre (DLR), INFRAS Zürich and ifeu – the Institute for Energy and Environmental Research in Heidelberg, they show in the Renewbility III project how that can be achieved: on behalf of the German Federal Environment Ministry, the project partners have investigated how the transport sector could be completely decarbonised by 2050.**

Climate-neutral transport is impossible without direct and efficient use of renewable electricity. Electricity-based fuels should only be used in situations in which electricity cannot be used directly, such as in aviation. A kilowatt-hour of electricity takes an electric vehicle up to ten times further than a car with a combustion engine that uses electricity-based fuel, because making that fuel requires a lot of energy. This means that there must be a major shift towards e-vehicles. According to Renewbility, electric transport can be encouraged by steadily tightening the CO<sub>2</sub> emission limits for cars – by 2050 the limit would need to be set at ten grams of CO<sub>2</sub> per kilometre, but a level of 95 grams per kilometre remains permissible from 2021. Fuel prices also need to be adjusted.

### Project profile

**Project title:** Renewbility III

**Contact:** Dr Wiebke Zimmer, [w.zimmer@oeko.de](mailto:w.zimmer@oeko.de)

**Institute Division:** Resources & Transport

**Client:** Federal Ministry for the Environment, Nature Conservation, Building and Nuclear Safety

**Project partners:** Institute for Transport Research at the German Aerospace Centre (DLR), INFRAS Zürich, ifeu – Institute for Energy and Environmental Research Heidelberg, tippingpoints – agency for sustainable communication

**Timescale:** October 2013 – November 2016

**Further information:**

[www.renewbility.de](http://www.renewbility.de)

### Dr Wiebke Zimmer

Dr Wiebke Zimmer, who studied chemistry and physics at university, is an expert in sustainable mobility. Since joining the Oeko-Institut in 2005, she has been developing strategies for CO<sub>2</sub> reduction in the transport sector. In 2013 she was appointed Deputy Head of the Institute's Resources & Transport Division.



*"Renwibility shows that measures to make the transport system climate-neutral also enhance our quality of life. They can reduce noise, accidents and pollutant emissions and make our inner cities more attractive places. Car use in the cities could be cut by about 50 percent."*

# Cadmium in TV screens

## Exemption requests under the RoHS Directive

The EU Directive on Restriction of Hazardous Substances (RoHS) is intended to restrict the use of hazardous substances in electrical and electronic equipment. Temporary exemptions from the restrictions can be granted if it is technically or scientifically impracticable to substitute an alternative, or if the alternative is prohibited or would have adverse impacts on humans and the environment. On behalf of the European Commission, the Oeko-Institut has examined two exemption requests for the use of cadmium in quantum dot technologies and produced recommendations for future exemption rules.

One of the uses of cadmium quantum dots is in televisions, where they enhance the colour and contrast of the image. However, cadmium is a heavy metal that is highly toxic; it is classed as carcinogenic and is therefore a prohibited substance under the RoHS Directive. In 2014 the Oeko-Institut submitted an evaluation report on exemption requests for cadmium quantum dots. In 2016 this report was updated and alternatives such as indium phosphide technology were also investigated. The evaluation was made particularly difficult by the existence of different standards for assessing the image quality

of cadmium-free versus cadmium quantum dot technology. Another issue is that energy consumption depends not only on the screen technology but also on the efficiency of the electronic circuit that activates the screen.

This meant that the Oeko-Institut could make recommendations only at the level of the technology comparison; it also used the latest standards for evaluating image quality. The study shows that

for the same image quality, cadmium-free screens use around 20 percent more energy than screens with cadmium quantum dots. The alternative substances used have no significant advantages or disadvantages. The decision was ultimately swung in favour of the exemption request by an evaluation criterion that specifies that replacement of the disputed substance must not result in displacement of environmental impacts. In this case the 20 percent higher energy consumption is such a displaced impact. However, the Oeko-Institut has suggested that the exemption should apply for a short period of just three years. This should incentivise innovations that improve TV images without having to use harmful substances.

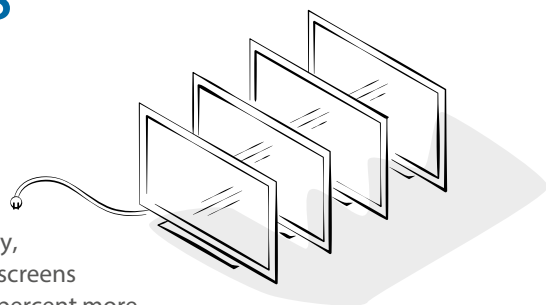

### Project profile

**Project title:** Study to assess 2 RoHS exemption requests

**Contact:** Yifaat Baron, [y.baron@oeko.de](mailto:y.baron@oeko.de)

**Institute Division:** Sustainable Products & Material Flows

**Client:** European Commission

**Timescale:** August 2015 – May 2016

**Further information:**

<http://rohs.exemptions.oeko.info>

### Yifaat Baron

Yifaat Baron has evaluated many exemption requests linked to substances banned under the RoHS and the equivalent directive on end-of-life vehicles (the ELV Directive) that applies to the automobile sector. For example, she has reported on the use of mercury in energy-saving lamps. She gained her MA in environmental management at the University of Haifa and has worked since 2012 at the Oeko-Institut, where she is now a Senior Researcher.

*“Our analysis makes clear that no technology is currently able to combine high image reproduction quality with high energy efficiency while avoiding the use of harmful substances. The recommended short validity of the exemption for cadmium quantum dots incentivises environmentally oriented refinement of screen technology.”*

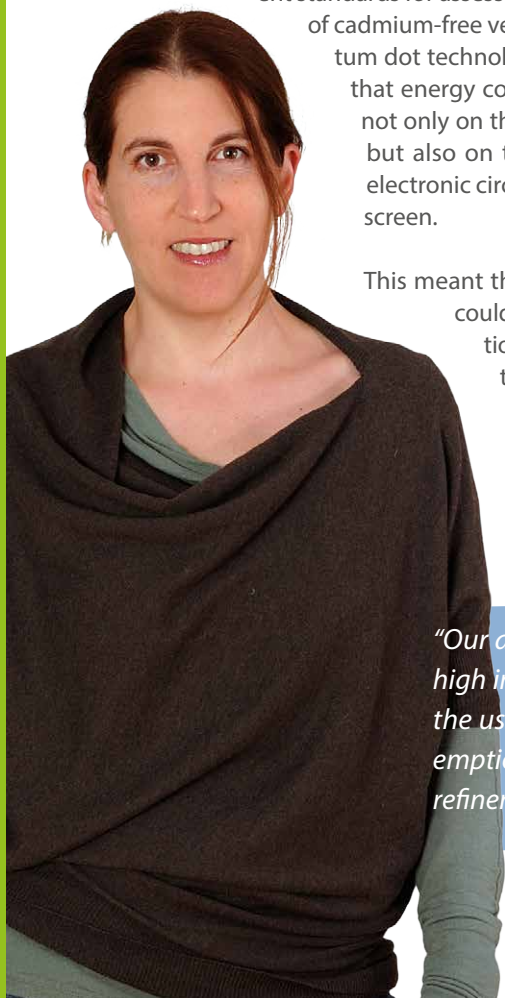

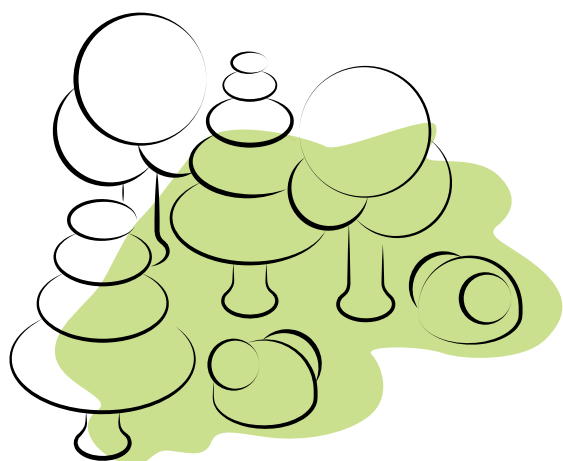

## A new pillar

### Reducing carbon emissions in agriculture and forestry

**It is impossible to tackle climate change without considering forestry and land. Forests, meadows and moors store carbon dioxide – although the CO<sub>2</sub> is released if the land is converted and put to agricultural use. Until 2016 the Land Use, Land-Use Change and Forestry (LULUCF) sector was ignored in the EU climate targets – but in July the European Commission submitted an initial proposal for including it. Prior to this the Oeko-Institut, on behalf of the NGO Fern, had outlined the advantages and disadvantages of various inclusion options and shown that LULUCF should not be combined with the other sectors.**

The Paris Climate Agreement contains an ambitious target: global warming is to be limited to 1.5 degrees. This cannot be achieved without a greater emphasis on LULUCF. A study produced by the Oeko-Institut in 2015 for the NGOs Fern and IFOAM showed that the already less stringent EU emission reduction targets would be watered down if the LULUCF sector was included in the European climate target without strict rules. For example, instead of reducing emissions, countries could count past afforestation as offsetting. The researchers therefore stated clearly that LULUCF should not be included in the Effort Sharing Decision but should constitute a separate pillar with its own targets, rules and commitments. The Effort Sharing Decision sets greenhouse gas emission targets for sectors outside the electricity sector, such as waste and transport; it is intended to contribute 30 percent of the EU's climate target, but including LULUCF could significantly weaken its effectiveness and reduce its contribution to 15.7 percent or less.

In 2016 the Oeko-Institut again stressed the need for a separate LULUCF pillar in climate change mitigation targets. Forestry and land could make an effective contribution to climate action and support achievement of an ambitious EU climate target. However, the project team views the European Commission's proposal of July 2016, which is to be the subject of further negotiations in 2017, as at best a compromise. While some of the Oeko-Institut's demands are taken into account, offsetting up to a certain limit is to be allowed.

#### Project profile

**Project title:** Going beyond 40% – options to ensure LULUCF maintains the high environmental integrity of the EU climate and energy package (2016)

**Impacts on the EU 2030 climate target of including LULUCF in the climate and energy policy framework (2015)**

**Contact:** Dr Hannes Böttcher, [h.boettcher@oeko.de](mailto:h.boettcher@oeko.de)

**Institute Division:** Energy & Climate (Berlin)

**Client:** Fern (2016), Fern, IFOAM (2015)

**Timescale:** January – February 2016 and April – June 2015

**Further information:** [www.oeko.de/lulucf](http://www.oeko.de/lulucf)

#### Dr Hannes Böttcher

Dr Hannes Böttcher gained his PhD in forest sciences in 2007 and has been a senior researcher at the Oeko-Institut since 2013. In his work at the Institute he focuses on issues such as carbon balances of forest ecosystems and land-use emissions and how to model them.

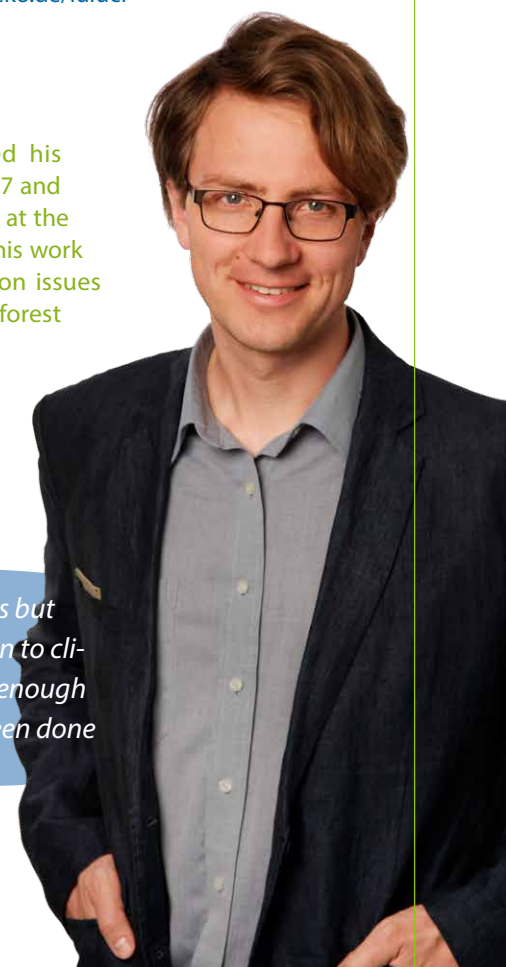

*"Our study in 2015 showed that the LULUCF sector needs not only special rules but also its own emission reduction targets if it is to make an effective contribution to climate change mitigation. The Commission's proposal of 2016 does not go far enough to maintain the level of ambition, let alone increase it. But that is what has been done by many non-European countries in Paris."*

# Safety: not good enough

## The Beznau and Fessenheim nuclear power plants

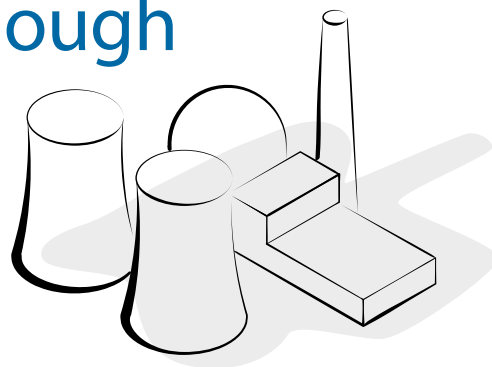

Germany's last nuclear power plant is due to shut down in 2022. Yet directly across the border, in one of Europe's most densely populated regions, two plants whose safety status give ample cause for concern will continue to run: Beznau in Switzerland, and Fessenheim in France. In two opinion papers, the Oeko-Institut has analysed the safety flaws of these nuclear power plants.

The plant in Fessenheim, France, meets substantially lower safety standards than the plants still running in Germany. The EU stress tests led to retrofits – for instance, mobile equipment was installed to ensure emergency power supply during a blackout. Yet even now, three years after the initial investigation, an analysis performed on behalf of the Baden-Württemberg Environment Ministry reveals that major weaknesses persist. One point singled out for criticism is the plant's low degree of redundancy: in Fessenheim, if more than one train breaks down due to a single failure in safety-relevant components such as cooling systems, safe operation will be compromised. In German plants, in contrast, when one train fails a further train can be undergoing repairs at the same time and the remaining systems will still suffice to maintain functionality. Moreover, the Fessenheim plant is poorly protected against external impacts.

Switzerland, too, hosts a nuclear power plant that is outdated in technology and design and, moreover, has a highly embrittled reactor pressure vessel: Beznau

1. This is the oldest nuclear power plant in the world. On-stream since 1969, it was shut down temporarily in 2015 after ultrasonic examination revealed more than 1000 clustered flaws in the material of the pressure vessel. It is here that the nuclear reaction takes place. If an accident in the reactor were to entail a brittle

fracture of the pressure vessel, the plant's safety systems would be unable to handle the situation, which could have disastrous consequences for both Switzerland and Germany. Commissioned by Greenpeace Switzerland, the Oeko-Institut's scientists assessed the flaws in the material and the way in which the operator intends to demonstrate the plant's safety. They found that a demonstration of physical integrity will only be possible – if at all – if the originally determined safety margins are reduced. Moreover, the documentation of integrity is subject to uncertainties.

### Project profile

**Project title:** Safety status of the Fessenheim nuclear power plant

Ultrasonic findings at the Beznau nuclear power plant

**Contact:** Simone Mohr, [s.mohr@oeko.de](mailto:s.mohr@oeko.de)

Dr Christoph Pistner, [c.pistner@oeko.de](mailto:c.pistner@oeko.de)

**Institute Division:** Nuclear Engineering & Facility Safety

**Client:** Baden-Württemberg Ministry of the Environment, Climate and Energy (Fessenheim)  
Greenpeace Switzerland (Beznau)

**Timescale:** April 2015 – January 2016 (Fessenheim)  
March 2016 – October 2016 (Beznau)

**Further information:** [bit.ly/2g0YFpo](http://bit.ly/2g0YFpo) (Fessenheim)  
[www.oeko.de/beznau](http://www.oeko.de/beznau)

### Simone Mohr

After graduating in engineering science, Simone Mohr worked for several years in plant engineering before joining the Oeko-Institut in 1995. In her capacity as Senior Researcher, she works on the safety of nuclear facilities and the management of spent nuclear fuel.

*"That outdated nuclear power plants located in the most densely populated areas have safety levels below the maximum possible is unacceptable. That should really go without saying. Reducing already established safety margins as a way of demonstrating physical integrity is intolerable."*





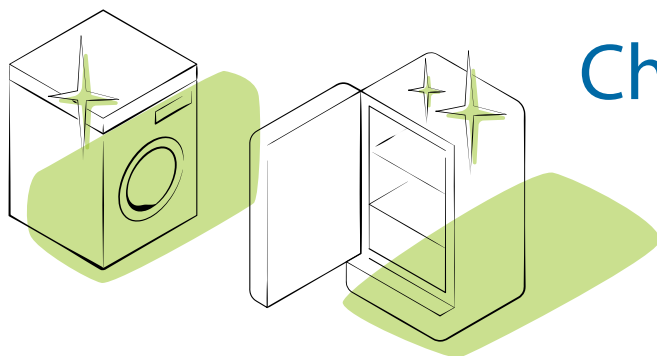

# Changing attitudes to consumption

## Strategies to counter obsolescence

**The electric kettle is broken? It's the manufacturer's fault! The next-door neighbour has a new TV? I want one too, even if the one I've got is still working. The lifetime and duration of use of electrical and electronic equipment is getting shorter. This obsolescence has many adverse impacts – on the environment, the climate and resources. But what is the cause? Is it defects that are systematically planned by manufacturers, or is it rampant consumerism? This question has long been a matter for debate. On behalf of the Federal Environment Agency, the Oeko-Institut and the University of Bonn have investigated the causes and consequences of obsolescence and created a solid information base; they have also proposed strategies to combat obsolescence.**

The study covered household appliances, information and communication technologies, and entertainment electronics. For most products, first-use duration has decreased in recent years. According to the study, the reasons for this are varied and differ between product groups. Purchases are driven by consumers' desires – in 2012 more than 60 per cent of functioning flatscreen TVs were replaced simply because consumers wanted to upgrade to a better product – as well as by defects. For example, the study found that the percentage of household appliances being replaced within five years due to defects more than doubled between 2004 and 2012.

The strategies for tackling premature obsolescence are equally varied. The responsibility lies in part with policy-makers, who can create the right framework via minimum standards for the quality and durability of electrical and electronic goods and their critical components. But manufacturers also have a part to play: the Oeko-Institut's proposals include requirements for more stringent information on issues such as pre-determined breaking points and consumable parts,

and better opportunities for repairs by making spare parts available and providing transparent information on repairs to independent repairers. The study also concludes that tackling the adverse consequences of obsolescence involves encouraging consumers away from thoughtless and excessive consumption.

### Project profile

**Project title:** Influence of the useful life of products on their environmental impact: Creating an information base and developing strategies against obsolescence

**Contact:** Siddharth Prakash, [s.prakash@oeko.de](mailto:s.prakash@oeko.de)

**Institute Division:** Sustainable Products & Material Flows

**Client:** Federal Environment Agency UBA

**Funding:** Environmental Research Plan of the Federal Ministry for the Environment, Nature Conservation, Building and Nuclear Safety

**Project partners:** University of Bonn

**Timescale:** September 2013 – September 2016

**Further information:**

[www.oeko.de/en/e-paper/obsolescence-causes-effects-strategies](http://www.oeko.de/en/e-paper/obsolescence-causes-effects-strategies)

### Siddharth Prakash

Siddharth Prakash joined the Oeko-Institut in 2008. In his work for the Institute he focuses on sustainable consumption, resource management and development cooperation with Asia and Africa. In 2016 the business magazine "Capital" nominated him as one of the "Young Elite" – Germany's top 40 entrepreneurs under the age of 40.

*"A new smartphone every year? That really isn't essential. But it is not only consumers who need to change their purchasing habits: combating premature obsolescence also calls for regulatory control. Policy-makers must act – and must encourage a circular economy. Because a longer product lifetime not only benefits the climate and saves resources – it also cuts costs."*



# The technologised plant

## Breeding between patents and variety rights

How flavourful a plant is, how high its vitamin content, and how well it grows – it has been a long time since characteristics such as these have solely been left to Mother Nature. There are many ways in which plant breeding can increase agricultural yields while simultaneously addressing challenges such as climate change and food security. Plant breeding has changed significantly, especially at the international level: more than 60 percent of the global seed market is now controlled by only ten companies. This is due, in part, to the cost-intensive and protracted development work in areas such as genetic engineering. The Oeko-Institut examined how these developments are linked to the regulatory framework governing variety rights in plant breeding.

As part of a project conducted by the Office of Technology Assessment at the German Bundestag (TAB), the project team analysed legal provisions in the areas of patent rights and plant variety rights, as developments in plant breeding are resulting in overlaps between these two areas of law in terms of the protection of intellectual property. Whether a plant that has been bred is given patent protection or variety protection determines the way in which it can be used for breeding purposes, among other things.

In its expert report, the project team gives an overview of the regulatory framework conditions in patent law and plant variety protection law. The analysis covers preconditions to protection and the scope of protection as well as infringements of plant variety protection and their consequences. The report also discusses the resultant difficulties in terms of demarca-

tion and the related problems and debates in Germany and Europe, showing that as a result of a practice of widely granting patents, especially at the EU level, patent law increasingly eclipses plant variety protection. However, only the latter is tailored to the special characteristics of the farming sector. In addition, the project team presents proposals for the advancement of protection rights in plant breeding, including approaches designed to prevent the ban on patenting being further undermined by essentially biological processes.

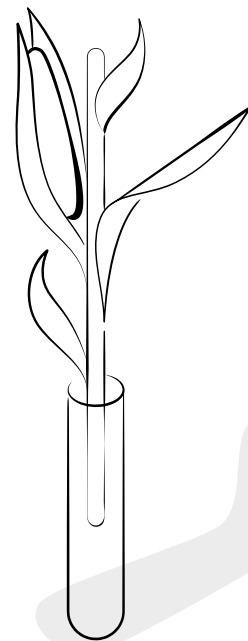

### Project profile

**Project title:** Challenges and approaches in the area of conflict between plant variety protection and patent protection

**Contact:** Ida Westphal, [i.westphal@oeko.de](mailto:i.westphal@oeko.de)

**Institute Division:** Environmental Law & Governance

**Client:** Deutscher Bundestag (German Federal Assembly)

**Timescale:** July 2016 – November 2016

**Further information:** [bit.ly/2geWl8b](https://bit.ly/2geWl8b)

### Ida Westphal

Ida Westphal works on topics related to national, European and international environmental law. At the Oeko-Institut, the legal professional has primarily worked on agri-environmental and resource conservation law as well as on legal aspects of corporate responsibility.

*“The process of concentration in plant breeding is also having an impact in Germany. The expansion of patent protection and the resultant economic pressure must not put specific production methods at a disadvantage. This is particularly true for organic farming, which often pays greater attention to regional specificities and thus contributes to maintaining biodiversity.”*



# Clients of the Oeko-Institut

## Politics & Government

- Abfallverwertungsgesellschaften (AVL) des Landkreises Ludwigsburg und des Neckar-Odenwald-Kreises
- Baden-Württemberg Ministry of the Environment, Climate and Energy
- Berlin Senate Department for Urban Development and Environment
- Bundesstelle für Energieeffizienz (BfEE)
- City of Munich
- Danish Ministry of Environment and Food
- Deutsche Gesellschaft für Internationale Zusammenarbeit (GIZ)
- Deutscher Bundestag
- European Commission
- European Parliament
- German Federal Agency for Nature Conservation (BfN)
- German Federal Offices for Economic Affairs and Export Control (BAFA) and for Radiation Protection (BfS)
- German Federal Environment Agency (UBA)
- German Federal Institute for Geosciences and Natural Resources (BGR)
- German Federal Ministry for Economic Affairs and Energy
- German Federal Ministry for Economic Cooperation and Development
- German Federal Ministry for the Environment, Nature Conservation, Building and Nuclear Safety
- German Federal Ministry of Education and Research
- German Federal Ministry of Transport and Digital Infrastructure
- Gernsbach Municipality
- Gesellschaft für Anlagen- und Reaktorsicherheit mbH (GRS)
- Hessian Ministry of the Environment, Climate Protection, Agriculture and Consumer Protection
- International Classification of Functioning, Disability and Health (ICF)
- Ministry of Finance, Republic of Ghana
- North Rhine-Westphalian Ministry for Climate Protection, Environment, Agriculture, Conservation and Consumer Protection
- North Rhine-Westphalian Ministry of Economy, Energy, Building, Housing and Transport
- North Rhine-Westphalian State Office for Nature, the Environment and Consumer Protection
- State Secretariat for Economic Affairs (SECO), Switzerland
- Western European Nuclear Regulators' Association (WENRA)

## Industry

- Apetito Convenience AB & Co.KG
- apple Distribution International
- Berner Trading Holding GmbH
- bofrost Dienstleistungs GmbH & Co. KG
- Business Engineering Institute St. Gallen
- CITEPA Centre Interprofessionnel Technique d'Etudes de la Pollution Atmosphérique
- Caparol GmbH
- Daimler AG
- Duales System Holding GmbH & Co.KG
- Entega Energie GmbH
- Eunomia Research & Consulting Ltd.
- Greenpeace Energy eG
- IWB Industrielle Werke Basel
- KeTAG Baden-Württemberg
- MEIKO Maschinenbau GmbH & Co.KG
- Miele & Cie.KG
- Saturn
- Shell Deutschland Oil GmbH
- Stadtwerke München GmbH
- Telekom AG
- TÜV Nord AG
- TÜV SÜD AG
- Tchibo GmbH
- Vaillant GmbH

## Civil society

- Agora Energiewende
- Baden-Württemberg Stiftung
- Climate Action Network (CAN)
- European Climate Foundation
- Forests and the European Union Resource Network
- Foundation for the Future / Stiftung Zukunftserbe
- Fraunhofer Institute for Systems and Innovation Research (ISI)
- Freie Universität Berlin
- German Aerospace Center (DLR)
- German Federal Environment Foundation (DBU)
- German Football Association
- German Institute for Economic Research (DIW)
- NABU
- Greenpeace
- Mercator Foundation / Stiftung Mercator
- North Rhine-Westphalian Consumer Advocacy Centre
- University of Applied Forest Sciences Rottenburg
- University of Freiburg
- WWF Germany
- Zeitbild Stiftung

A full list of references is available (in German) at [www.oeko.de/referenzen2016](http://www.oeko.de/referenzen2016)

# Paving the way for the future

## The structure and management of the Oeko-Institut

The Oeko-Institut is a non-profit association that was established in 1977. The Committee is elected by the members at the annual General Assembly. The Committee members serve for two years on an honorary basis. The Executive Board directs the ongoing work of the Institute, collaborating closely

with the Institute's research divisions and the various departments of Central Services.

In 2016 the Infrastructure & Enterprises Division was renamed Resources & Transport in order to better reflect the focus of the Division's activities.

### Advisory Board

Prof. Dr Nina Buchmann  
 Dr Susanne Dröge  
 Dr Erhard Eppler  
 Prof. Dr Klaus Fricke  
 Prof. Dr Martin Führ  
 Prof. Dr Regine Kollek  
 Prof. Dr Ellen Matthies  
 Prof. Dr Peter C. Mayer-Tasch  
 Dr Inge Paulini  
 Prof. Dr Eckard Rehbinder  
 Prof. Dr Lucia Reisch  
 Dr Hartmut Richter  
 Prof. em. Dr Udo E. Simonis

### Committee

#### External members of the Committee

Dorothea Michaelsen-Friedlieb – First Chair of the Committee  
 Ulrike Schell – Second Chair of the Committee  
 Dr Regina Betz  
 Prof. Dr Gerald Kirchner  
 Thomas Rahner  
 Kathleen Spilok  
 Prof. Dr Volrad Wollny

#### Internal members of the Committee

Vanessa Cook  
 Dr Georg Mehlhart  
 Michael Sailer  
 Tobias Schleicher  
 Christof Timpe

### Executive Board



**Michael Sailer**  
 CEO  
[m.sailer@oeko.de](mailto:m.sailer@oeko.de)

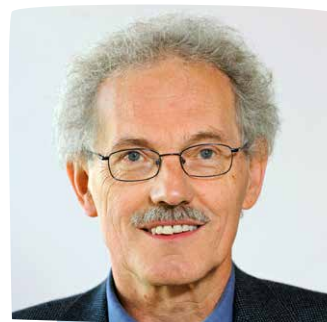

**Prof. Dr Rainer Griesshammer**  
[r.griesshammer@oeko.de](mailto:r.griesshammer@oeko.de)



**Susanne Fröschl**  
[s.froeschl@oeko.de](mailto:s.froeschl@oeko.de)

# Research Divisions and Central Services



**Christof Timpe**  
Head of the Energy &  
Climate Division  
(Freiburg/Darmstadt)  
[c.timpe@oeko.de](mailto:c.timpe@oeko.de)



**Dr Martin Cames**  
Head of the Energy  
& Climate Division  
(Berlin)  
[m.cames@oeko.de](mailto:m.cames@oeko.de)



**Beate  
Kallenbach-Herbert**  
Head of the Nuclear  
Engineering & Facility  
Safety Division  
[b.kallenbach@oeko.de](mailto:b.kallenbach@oeko.de)



**Dr Matthias Buchert**  
Head of the Resources  
& Transport Division  
[m.buchert@oeko.de](mailto:m.buchert@oeko.de)



**Carl-Otto Gensch**  
Head of the  
Sustainable Products  
& Material Flows  
Division  
[c.gensch@oeko.de](mailto:c.gensch@oeko.de)



**Franziska Wolff**  
Head of the  
Environmental Law &  
Governance Division  
[f.wolff@oeko.de](mailto:f.wolff@oeko.de)



**Boris Hüttmann**  
Head of the  
IT Department  
[b.huettmann@oeko.de](mailto:b.huettmann@oeko.de)



**Thomas Manz**  
Head of the Tenders &  
Contracts Department  
[t.manz@oeko.de](mailto:t.manz@oeko.de)



**Susanne Rossbach**  
Head of the  
Finance & Accounting  
Department  
[s.rossbach@oeko.de](mailto:s.rossbach@oeko.de)



**Mandy Schossig**  
Head of the Public  
Relations & Communi-  
cations Department  
[m.schossig@oeko.de](mailto:m.schossig@oeko.de)

# Many ways of communication

**Obsolescence, nuclear repositories, the raw materials transition: these are just some of the issues that dominated the Oeko-Institut's communication activities in 2016. The Public Relations & Communications Department was also heavily involved in the relaunch of our website, the planning and organisation of our Annual Conference, research into the Institute's history and the preliminary plans for our forthcoming anniversary celebrations.**

Website editing, active press work, providing contacts and developing communication strategies are an important part of our public relations work. In addition we use social media (Twitter, Youtube, Flickr, Slideshare) as high-speed, high-impact communication channels that are steadily gaining public acceptance. For our members we publish *eco@work*, which is available to all free of charge on the internet. And we provide editorial assistance to the research divisions in producing project websites, leaflets and brochures and other publications such as the latest Sustainability Report.

Every day the department sifts through the responses to our media activities in the press, on radio and television and in online media. Some highlights of 2016:

## Lead recycling

*"In terms of health and the environment, the conditions under which old lead batteries are recycled in Africa are disastrous, said Tobias Schleicher of the Oeko-Institut's Freiburg office on the DLF radio channel. The countries involved must take action themselves and introduce basic standards. [...]"*

(Deutschlandfunk, 23 May 2016)

## The energy transition

*"Rainer Griesshammer is a member of the Executive Board of the Oeko-Institut, a non-profit environmental research institute based in Freiburg im Breisgau; he is coordinating [...] 33 research and development projects funded by the Federal Ministry of Education and Research that aim to bring about an 'environmentally and socially compatible transformation of the energy system'. [...]"*

(Frankfurter Rundschau, 4 October 2016)

## Safety risk

*"We have old reactors at various places in Europe that for this and other reasons are unsafe. And policy-makers must now finally decide that this risk should be eliminated," says Michael Sailer in an interview on the TV news programme Tagesschau about the heightened safety risk at a number of European nuclear power plants.*

(ARD, 24 November 2016)

## Relaunch of the website oeko.de

In the summer we restructured our website [www.oeko.de/en/](http://www.oeko.de/en/) and treated it to a new layout. The new design makes it easier to access information on our research topics, read about our ongoing research work and search the databases for publications and projects. And *eco@work* is now incorporated into the page structure and is thus a real online magazine.

[www.oeko.de/e-paper](http://www.oeko.de/e-paper)

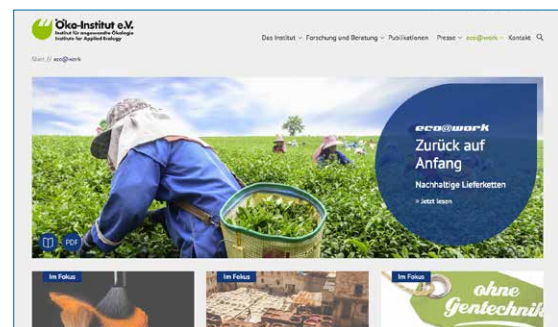

## Annual conference "Germany 2049"

In December some 180 guests attended the Oeko-Institut's annual conference in Berlin on the subject of "Germany 2049: Transition to a sustainable use of raw materials", where they discussed the challenges of sustainable raw materials management and possible strategies and solutions. The Public Relations & Communications Department helped with event organisation and communications; photos, videos and a post-event report are available on the website [www.oeko.de](http://www.oeko.de).

[www.oeko.de/jahrestagung2016](http://www.oeko.de/jahrestagung2016)



# Hand-in-hand with society

## The Oeko-Institut's members

Some 2300 members regularly support our work with donations and subscriptions, thereby enabling us to conduct studies that do not form part of the projects financed by our clients. This support ensures that we can pursue projects for which we receive no funding from other sources but that nevertheless address important environmental issues or identify prospects for the future. It means that we can continue to fulfil our "signposting" role and maintain the independence that is so important to us.

An example of these self-funded projects is the study "Germany 2049: Transition to a sustainable use of raw materials", which was described on page 9. Our researchers have spent three years drawing up a strategy for a forward-looking raw materials policy. Similarly, the specific donations that we request each year for our donation-funded project also guarantee independent and critical research.

**We thank you very warmly for this continuing support!**

### New donation-funded project "Environmental protection and human rights" launched

In November 2016 we launched a new donation-funded project that explores the links between environmental damage and human rights abuses. In the project "Protecting the environment protects human rights" the Oeko-Institut considers copper mining in Peru, shipbreaking in Bangladesh and the sale in countries of the global South of pesticides and herbicides that are banned in Germany. The focus is on German companies, who as buyers, suppliers or disposal businesses are often accused of causing environmental damage that infringes human rights.

In the donation-funded project we are asking companies about the precautions they take to prevent environmental damage and human rights abuses in other countries. We are also investigating what opportunities victims have to take legal action against the companies responsible, and identifying where there are gaps in the law. The aim is to draw up requirements for policy-makers and businesses to ensure better protection of the environment and human rights.

Further information:  
[www.oeko.de/spendenprojekt2016](http://www.oeko.de/spendenprojekt2016)

**To continue working on projects that are particularly important to us and urgent from an environmental point of view, we need your help. Please support us with a donation!**

There are plenty of opportunities for donations to the Oeko-Institut not linked to our donation-funded projects. Perhaps you are celebrating a birthday, wedding, summer fair, company anniversary or church festival and would like to request donations to a good

cause in place of presents. Why not ask your relatives and friends for donations to the Oeko-Institut? At funerals, too, many families request donations to a good cause instead of flowers.

### Or support us regularly and become a member of the Oeko-Institut!

For further information visit our members' website  
<http://mitglieder.oeko.de>

**Bank details for donations:**  
GLS Bank  
IBAN: DE50 4306 0967 7922 0099 00  
BIC: GENODEM1GLS

**Contact for members:**  
Andrea Droste  
Tel.: +49 761 45295-249  
E-mail: [a.droste@oeko.de](mailto:a.droste@oeko.de)

**Freiburg Head Office**

PO Box 1771  
D-79017 Freiburg  
Merzhauser Strasse 173  
D-79100 Freiburg  
Tel.: +49 761 45295-0  
Fax: +49 761 45295-288

**Darmstadt Office**

Rheinstrasse 95  
D-64295 Darmstadt  
Tel.: +49 6151 8191-0  
Fax: +49 6151 8191-133

**Berlin Office**

Schicklerstrasse 5-7  
D-10179 Berlin  
Tel.: +49 30 405085-0  
Fax: +49 30 405085-388

[info@oeko.de](mailto:info@oeko.de)  
[www.oeko.de](http://www.oeko.de)